

Jeep®

User Guide



2013
Compass

If you are the first registered retail owner of your vehicle, you may obtain a complimentary printed copy of the Owner's Manual, Navigation/Uconnect® Manuals or Warranty Booklet by calling 1-877-426-5337 (U.S.) or 1-800-387-1143 (Canada) or by contacting your dealer.

The driver's primary responsibility is the safe operation of the vehicle. Driving while distracted can result in loss of vehicle control, resulting in a collision and personal injury. Chrysler Group LLC strongly recommends that the driver use extreme caution when using any device or feature that may take their attention off the road. Use of any electrical devices such as cell phones, computers, portable radios, vehicle navigation or other devices by the driver while the vehicle is moving is dangerous and could lead to a serious collision. Texting while driving is also dangerous and should never be done while the vehicle is moving. If you find yourself unable to devote your full attention to vehicle operation, pull off the road to a safe location and stop your vehicle. Some States or Provinces prohibit the use of cellular telephones or texting while driving. It is always the driver's responsibility to comply with all local laws.

Important:

This User Guide is intended to familiarize you with the important features of your vehicle. **The DVD enclosed contains your Owner's Manual, Navigation/Uconnect® Manuals, Warranty Booklets, Tire Warranty and Roadside Assistance (new vehicles purchased in the U.S.) or Roadside Assistance (new vehicles purchased in Canada) in electronic format.** We hope you find it useful. Replacement DVD kits may be purchased by visiting www.techauthority.com. Jeep® is a registered trademark of Chrysler Group LLC. © 2013 Chrysler Group LLC.

TABLE OF CONTENTS

INTRODUCTION/WELCOME

WELCOME FROM CHRYSLER GROUP LLC	2
---	---

CONTROLS AT A GLANCE

DRIVER COCKPIT	6
INSTRUMENT CLUSTER	8

GETTING STARTED

KEY FOB	10
REMOTE START	11
THEFT ALARM	11
SEAT BELT	12
SUPPLEMENTAL RESTRAINT SYSTEM (SRS) — AIR BAGS	13
CHILD RESTRAINTS	14
FRONT SEATS	16
REAR SEATS	18
TILT STEERING COLUMN	18
HEATED SEATS	19

OPERATING YOUR VEHICLE

ENGINE BREAK-IN RECOMMENDATIONS	20
TURN SIGNAL/LIGHTS LEVER	21
WIPER/WASHER LEVER	22
SPEED CONTROL	23
CONTINUOUSLY VARIABLE AUTOMATIC TRANSMISSION (CVT)	24
MANUAL CLIMATE CONTROLS	24
AUTOMATIC TEMPERATURE CONTROLS (ATC)	25
POWER SUNROOF	26
WIND BUFFETING	27

ELECTRONICS

YOUR VEHICLE'S SOUND SYSTEM	28
Uconnect® 130	30
Uconnect® 130 WITH SiriusXM SATELLITE RADIO	32
Uconnect® 230	35
Uconnect® 430/430N	38
SiriusXM SATELLITE RADIO/TRAVEL LINK	48
STEERING WHEEL AUDIO CONTROLS	52
iPod®/USB/MP3 CONTROL	52
Uconnect® Phone	53
Uconnect® VOICE COMMAND	57
Bluetooth® STREAMING AUDIO	59
ELECTRONIC VEHICLE INFORMATION CENTER (EVIC)	60
PROGRAMMABLE FEATURES	61
UNIVERSAL GARAGE DOOR OPENER (HomeLink®)	62
POWER INVERTER	65
POWER OUTLET	66

OFF-ROAD CAPABILITIES

FOUR-WHEEL DRIVE OPERATION	67
--------------------------------------	----

UTILITY

TRAILER TOWING WEIGHTS (MAXIMUM TRAILER WEIGHT RATINGS)	69
RECREATIONAL TOWING (BEHIND MOTORHOME, ETC.)	69

WHAT TO DO IN EMERGENCIES

ROADSIDE ASSISTANCE	70
INSTRUMENT CLUSTER WARNING LIGHTS	70
IF YOUR ENGINE OVERHEATS	74
AUTOMATIC TRANSMISSION OVERHEATING	75
JACKING AND TIRE CHANGING	75
JUMP-STARTING PROCEDURES	81
SHIFT LEVER OVERRIDE	83
TOWING A DISABLED VEHICLE	84
FREEING A STUCK VEHICLE	85
EVENT DATA RECORDER (EDR)	86

MAINTAINING YOUR VEHICLE

OPENING THE HOOD	87
ENGINE COMPARTMENT	88
FLUIDS AND CAPACITIES	90
MAINTENANCE SCHEDULE	91
MAINTENANCE RECORD	95
FUSES	96
TIRE PRESSURES	97
WHEEL AND WHEEL TRIM CARE	98
EXTERIOR BULBS	98

CONSUMER ASSISTANCE

CHRYSLER GROUP LLC CUSTOMER CENTER	99
CHRYSLER CANADA INC. CUSTOMER CENTER	99
ASSISTANCE FOR THE HEARING IMPAIRED	99
PUBLICATIONS ORDERING	99
REPORTING SAFETY DEFECTS IN THE 50 UNITED STATES AND WASHINGTON, D.C.	100

MOPAR ACCESSORIES

AUTHENTIC ACCESSORIES BY MOPAR®	101
---	-----

INDEX	102
------------------------	-----

FAQ (How To?)

FREQUENTLY ASKED QUESTIONS	105
--------------------------------------	-----

INTRODUCTION/WELCOME

WELCOME FROM CHRYSLER GROUP LLC

Congratulations on selecting your new Chrysler Group LLC vehicle. Be assured that it represents precision workmanship, distinctive styling, and high quality - all essentials that are traditional to our vehicles.

Your new Chrysler Group LLC vehicle has characteristics to enhance the driver's control under some driving conditions. These are to assist the driver and are never a substitute for attentive driving. They can never take the driver's place. Always drive carefully.

Your new vehicle has many features for the comfort and convenience of you and your passengers. Some of these should not be used when driving because they take your eyes from the road or your attention from driving. Never text while driving or take your eyes more than momentarily off the road.

This guide illustrates and describes the operation of features and equipment that are either standard or optional on this vehicle. This guide may also include a description of features and equipment that are no longer available or were not ordered on this vehicle. Please disregard any features and equipment described in this guide that are not available on this vehicle. Chrysler Group LLC reserves the right to make changes in design and specifications and/or make additions to or improvements to its products without imposing any obligation upon itself to install them on products previously manufactured.

This User Guide has been prepared to help you quickly become acquainted with the important features of your vehicle. It contains most things you will need to operate and maintain the vehicle, including emergency information.

The DVD includes a computer application containing detailed owner's information which can be viewed on a personal computer or MAC computer. The multimedia DVD also includes videos which can be played on any standard DVD player (including the Uconnect® Touch-Screen Radios). Additional DVD operational information is located on the back of the DVD sleeve.

For complete owner information, refer to your Owner's Manual on the DVD in the owner's kit provided at the time of new vehicle purchase. For your convenience, the information contained on the DVD may also be printed and saved for future reference.

Chrysler Group LLC is committed to protecting our environment and natural resources. By converting from paper to electronic delivery for the majority of the user information for your vehicle, together we greatly reduce the demand for tree-based products and lessen the stress on our environment.

INTRODUCTION/WELCOME

VEHICLES SOLD IN CANADA

With respect to any vehicles sold in Canada, the name Chrysler Group LLC shall be deemed to be deleted and the name Chrysler Canada Inc. used in substitution.

WARNING!

- Pedals that cannot move freely can cause loss of vehicle control and increase the risk of serious personal injury.
- Always make sure that objects cannot fall into the driver foot well while the vehicle is moving. Objects can become trapped under the brake pedal and accelerator pedal causing a loss of vehicle control.
- Failure to properly follow floor mat installation or mounting can cause interference with the brake pedal and accelerator pedal operation causing loss of control of the vehicle.
- Never use the 'PARK' position as a substitute for the parking brake. Always apply the parking brake fully when parked to guard against vehicle movement and possible injury or damage.
- Refer to your Owner's Manual on the DVD for further details.

INTRODUCTION/WELCOME

Rollover Warning



WARNING!

- Pedals that cannot move freely can cause loss of vehicle control and increase the risk of serious personal injury.
- Always make sure that objects cannot fall into the driver foot well while the vehicle is moving. Objects can become trapped under the brake pedal and accelerator pedal causing a loss of vehicle control.
- Failure to properly follow floor mat installation or mounting can cause interference with the brake pedal and accelerator pedal operation causing loss of control of the vehicle.
- Refer to your Owner's Manual on the DVD for further details.
- Never use the 'PARK' position as a substitute for the parking brake. Always apply the parking brake fully when parked to guard against vehicle movement and possible injury or damage.

INTRODUCTION/WELCOME

USE OF AFTERMARKET PRODUCTS (ELECTRONICS)

The use of aftermarket devices including cell phones, MP3 players, GPS systems, or chargers may affect the performance of on-board wireless features including Keyless Enter-N-Go™ and Remote Start range. If you are experiencing difficulties with any of your wireless features, try disconnecting your aftermarket devices to see if the situation improves. If your symptoms persist, please see an authorized dealer.

CHRYSLER, DODGE, JEEP, RAM TRUCK, SRT, ATF+4, MOPAR and Uconnect are registered trademarks of Chrysler Group LLC.

COPYRIGHT ©2012 CHRYSLER GROUP LLC



CONTROLS AT A GLANCE

6 DRIVER COCKPIT



CONTROLS AT A GLANCE



- A. Turn Signal/Lights Lever pg. 21
- B. Electronic Vehicle Information Center (EVIC) Controls pg. 60
- C. Electronic Vehicle Information Center (EVIC) Display
- D. Instrument Cluster pg. 8
- E. Wiper/Washer Lever pg. 22
- F. Audio System (non-touch-screen radio shown) pg. 30
- G. Climate Controls pg. 24
- H. Power Outlet/Cigar Lighter pg. 66
- I. Transmission Gear Selector
- J. SWITCH PANEL
 - Heated Seat Switches pg. 19
 - Electronic Stability Control pg. 70
 - Hazard Switch
- K. Electronic Speed Control pg. 23
- L. Tilt Steering Column Lever pg. 18
- M. Power Mirrors
- N. Power Door Locks
- O. Power Windows

CONTROLS AT A GLANCE



INSTRUMENT CLUSTER

Warning Lights

-  - Low Fuel Warning Light
-  - Charging System Light**
-  - Oil Pressure Warning Light**
-  - Anti-Lock Brake (ABS) Light**
-  - Air Bag Warning Light**
-  - Electronic Throttle Control (ETC) Light
-  - Tire Pressure Monitoring System (TPMS) Light
-  - Engine Temperature Warning Light
-  - Transmission Temperature Warning Light
-  - Seat Belt Reminder Light
- BRAKE**  - Brake Warning Light**
-  - Malfunction Indicator Light (MIL)**
-  - Electronic Stability Control (ESC) Activation/Malfunction Indicator Light**
- 4WD!**  - 4WD System Fault Indicator Light**

(See page 70 for more information.)

CONTROLS AT A GLANCE



Indicators



- Turn Signal Indicators



- High Beam Indicator



- Front Fog Light Indicator



- Vehicle Security Indicator*

4WD

- 4WD Indicator



- Electronic Stability Control (ESC) Off Indicator

CRUISE

- Speed Control Indicator



- Hill Descent Control Indicator

Odometer Messages

door - Door Ajar

LoW tirE - Low Tire Pressure

gATE - GateAjar

CHANGe OIL* - Change Engine Oil

gASCAP - Fuel Cap Fault

* If equipped

** Bulb Check with Key On

GETTING STARTED

KEY FOB

Locking And Unlocking The Doors/Liftgate

- Press the LOCK button once to lock all the doors and the liftgate. Press the UNLOCK button once to unlock the driver's door only and twice within five seconds to unlock all the doors and liftgate.
- All doors can be programmed to unlock on the first press of the UNLOCK button. Refer to Programmable Features in the Electronics section of this guide.



Panic Alarm

- Press the PANIC button once to turn the panic alarm on.
- Wait approximately three seconds and press the button a second time to turn the panic alarm off.

WARNING!

- When leaving the vehicle, always remove the key fob from the ignition and lock your vehicle.
- Never leave children alone in a vehicle, or with access to an unlocked vehicle. Allowing children to be in a vehicle unattended is dangerous for a number of reasons. A child or others could be seriously or fatally injured. Children should be warned not to touch the parking brake, brake pedal or the shift lever.
- Do not leave the key fob in the vehicle, or in a location accessible to children. A child could operate power windows, other controls, or move the vehicle.

GETTING STARTED

REMOTE START

NOTE:

The vehicle must be equipped with an automatic transaxle to be equipped with Remote Start.

- Press the REMOTE START button  on the Key Fob twice within five seconds. Pressing the REMOTE START button a third time shuts the engine off.
- To drive the vehicle, press the UNLOCK button, insert the key in the ignition and turn to the ON/RUN position.
- With remote start, the engine will only run for 15 minutes (timeout) unless the ignition key is placed in the ON/RUN position.
- The vehicle must be started with the key after two consecutive timeouts.

WARNING!

- Do not start or run an engine in a closed garage or confined area. Exhaust gas contains Carbon Monoxide (CO) which is odorless and colorless. Carbon Monoxide is poisonous and can cause serious injury or death when inhaled.
- Keep Key Fob transmitters away from children. Operation of the Remote Start System, windows, door locks or other controls could cause serious injury or death.

THEFT ALARM

To Arm:

- Press the Key Fob LOCK button or the power door lock switch while the door is open.

To Disarm:

- Press the Key Fob UNLOCK button or turn the ignition to the ON/RUN position.

GETTING STARTED

SEAT BELT

- Be sure everyone in your vehicle is in a seat and using a seat belt properly.
- Position the lap belt across your thighs, below your abdomen. To remove slack in the lap portion, pull up a bit on the shoulder belt. To loosen the lap belt if it is too tight, tilt the latch plate and pull on the lap belt. A snug belt reduces the risk of sliding under the belt in a collision.
- Position the shoulder belt on your chest so that it is comfortable and not resting on your neck. The retractor will withdraw any slack in the belt.
- A shoulder belt placed behind you will not protect you from injury during a collision. You are more likely to hit your head in a collision if you do not wear your shoulder belt. The lap and shoulder belt are meant to be used together.
- A belt that is too loose will not protect you properly. In a sudden stop you could move too far forward, increasing the possibility of injury. Wear your seat belt snugly.
- A frayed or torn belt could rip apart in a collision and leave you with no protection. Inspect the belt system periodically, checking for cuts, frays, or loose parts. Damaged parts must be replaced immediately. Do not disassemble or modify the system. Seat belt assemblies must be replaced after a collision if they have been damaged (bent retractor, torn webbing, etc.).
- The seat belts for both front seating positions are equipped with pretensioning devices that are designed to remove slack from the seat belt in the event of a collision.
- A deployed pretensioner or a deployed air bag must be replaced immediately.

WARNING!

In a collision, you and your passengers can suffer much greater injuries if you are not buckled up properly. You can strike the interior of your vehicle or other passengers, or you can be thrown out of the vehicle. Always be sure you and others in your vehicle are buckled up properly.

GETTING STARTED

SUPPLEMENTAL RESTRAINT SYSTEM (SRS) – AIR BAGS

- This vehicle has Advanced Front Air Bags for both the driver and right front passenger as a supplement to the seat belt restraint system. The Advanced Front Air Bags will not deploy in every type of collision.
- Advanced Front Air Bags are designed to provide additional protection by supplementing the seat belts in certain frontal collisions depending on several factors, including the severity and type of collision. Advanced Front Air Bags are not expected to reduce the risk of injury in rear, side, or rollover collisions.
- This vehicle is equipped with Supplemental Side Air Bag Inflatable Curtains to protect the driver, front and rear passengers sitting next to a window.
- This vehicle may be equipped with Supplemental Seat-Mounted Side Air Bags to provide enhanced protection to help protect an occupant during a side impact.
- If the Air Bag Warning Light  is not on during starting, stays on, or turns on while driving, have the vehicle serviced by an authorized service center immediately.
- Refer to the Owner's Manual on the DVD for further details regarding the Supplemental Restraint System (SRS).

WARNING!

- Relying on the air bags alone could lead to more severe injuries in a collision. The air bags work with your seat belt to restrain you properly. In some collisions, the air bags won't deploy at all. Always wear your seat belts even though you have air bags.
- Being too close to the steering wheel or instrument panel during Advanced Front Air Bag deployment could cause serious injury, including death. Air bags need room to inflate. Sit back, comfortably extending your arms to reach the steering wheel or instrument panel.
- Being too close to the Supplemental Side Air Bag Inflation Curtain and/or Seat-Mounted Side Air Bag during deployment could cause you to be severely injured or killed.
- Supplemental Side Air bag Inflatable Curtains and Supplemental Seat-Mounted Side Air Bags need room to inflate. Do not lean against the door or window. Sit upright in the center of the seat.
- Do not drive your vehicle after the air bags have developed. If you are involved in another collision, the air bags will not be in place to protect you.
- After any collision, the vehicle should be taken to an authorized dealer immediately.

GETTING STARTED

CHILD RESTRAINTS

- Children 12 years and under should ride properly buckled up in a rear seat, if available. According to crash statistics, children are safer when properly restrained in the rear seats rather than in the front.
- Every state in the United States and all Canadian provinces require that small children ride in proper restraint systems. This is the law, and you can be prosecuted for ignoring it.

NOTE:

- For additional information, refer to www.seatcheck.org or call 1-866-SEAT-CHECK (1-866-732-8243).
- Canadian residents, should refer to Transport Canada's website for additional information.
 - <http://www.tc.gc.ca/eng/roadsafety/safedrivers-childsafety-index-53.htm>

Installing The LATCH - Compatible Child Restraint System

- Your vehicle's second row passenger seats are equipped with the child restraint anchorage system called LATCH, which stands for Lower Anchors and Tether for CHildren. LATCH child restraint anchorage systems are installed at all three rear seating positions.
- The rear outboard seating positions have lower anchors, and all three rear seating positions have top tether anchors.
- Child seats with fixed lower attachments must be installed in the outboard positions only. Child seats with flexible lower attachments can be used in all three seating positions.
- **NEVER** install LATCH-compatible child seats such that two seats share a common lower anchorage.
- Loosen the child seat adjusters on the lower straps and tether straps so that you can attach the hook or connector to the lower and tether anchorages more easily.
- Attach the lower hooks or connectors over the top of the seatcover material.



GETTING STARTED

- The tether strap should be routed under the center of the head restraint and attached to the tether anchor on the rear of the seatback.
- Tighten all three straps as you push the child restraint rearward and downward into the seat.



Installing The Child Restraint Using The Vehicle Seat Belts

- To install a child restraint, first, pull enough of the seat belt webbing from the retractor to route it through the belt path of the child restraint and slide the latch plate into the buckle.
- Next, extract all the seat belt webbing out of the retractor and then allow the belt to retract into the retractor. Finally, pull on any excess webbing to tighten the lap portion around the child restraint. Any seat belt system will loosen with time, so check the belt occasionally, and pull it tight if necessary.
- Once you have completed securing the child restraint with the seat belt, secure the top tether strap. The tether strap should be routed over the center top of the head restraint.

WARNING!

- In a collision, an unrestrained child, even a tiny baby, can become a projectile inside the vehicle. The force required to hold even an infant on your lap could become so great that you could not hold the child, no matter how strong you are. The child and others could be severely injured or killed. Any child riding in your vehicle should be in a proper restraint for the child's size.
- Rearward-facing child seats must never be used in the front seat of a vehicle with a front passenger air bag. An air bag deployment could cause severe injury or death to infants in this position.
- Improper installation of a child restraint to the LATCH anchorages can lead to failure of an infant or child restraint. The child could be severely injured or killed. Follow the manufacturer's directions exactly when installing an infant or child restraint.
- An incorrectly anchored tether strap could lead to increased head motion and possible injury to the child. Use only the anchor positions directly behind the child seat to secure a child restraint top tether strap.

GETTING STARTED

FRONT SEATS

Power Seats

- The power seat switch is located on the outboard side of the seat near the floor. Use the switch to move the seat up, down, forward, rearward, or to tilt the seat.



MANUAL SEAT

Forward/Rearward

- Lift up on the adjusting bar located at the front of the seat near the floor and release it when the seat is at the desired position. Then, using body pressure, move forward and backward on the seat to be sure that the seat adjusters have latched.

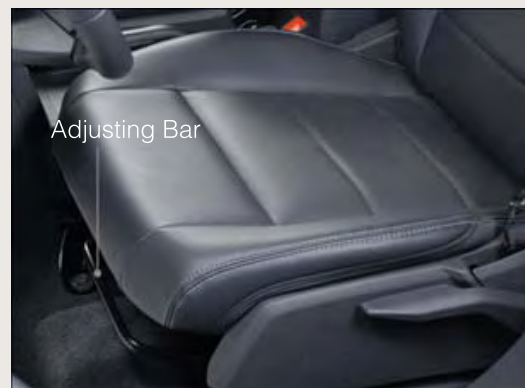

Recliner

- Lift the recliner handle located on the outboard side of the seat, lean back and release at the desired position.

Driver's Seat Height Adjustment

- The height adjustment lever is located on the outboard side of the seat. Raise the lever to raise the seat. Lower the lever to lower the seat.

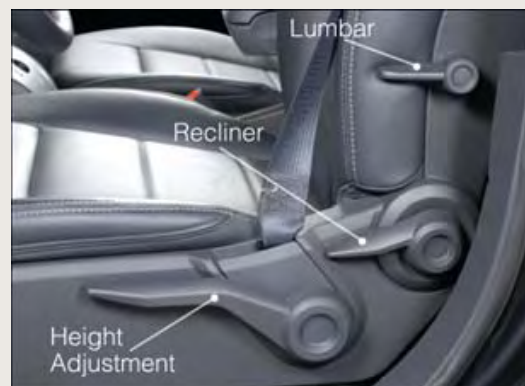

Lumbar Support

- The lumbar lever is on the outboard side of the seatback. Rotate the lumbar lever downward to increase the lumbar support or upward to decrease the lumbar support as desired.

GETTING STARTED

Fold-Flat Front Passenger Seat

- The front passenger seat can be folded flat. Pull up on the recliner handle, to the full upward position, to fold down the seatback.



CAUTION!

Do not place any article under a power seat or impede its ability to move as it may cause damage to the seat controls. Seat travel may become limited if movement is stopped by an obstruction in the seat's path.

WARNING!

- Adjusting a seat while the vehicle is moving is dangerous. The sudden movement of the seat could cause you to lose control. The seat belt might not be properly adjusted, and you could be severely injured or killed. Only adjust a seat while the vehicle is parked.
- Do not ride with the seatback reclined so that the seat belt is no longer resting against your chest. In a collision, you could slide under the seat belt and be severely injured or killed. Use the recliner only when the vehicle is parked.

GETTING STARTED

REAR SEATS

Folding Rear Seatback

- To fold each rear seatback, pull the strap forward to move the seatback forward and flat.

Reclining Rear Seatback

- To recline each rear seatback, pull the strap forward just enough to release the seatback latch. Then push the seatback to a reclined position, approximately 35 degrees maximum, and release the strap.



WARNING!

Be certain that the seatback is securely locked into position. If the seatback is not securely locked into position, the seat will not provide the proper stability for child seats and/or passengers. An improperly latched seat could cause serious injury.

TILT STEERING COLUMN

- The tilt lever is located on the steering column, below the turn signal lever.
- Push down on the lever to unlock the steering column.
- With one hand firmly on the steering wheel, move the steering column up or down as desired.
- Pull upward on the lever to lock the column firmly in place.



WARNING!

Do not adjust the steering column while driving. Adjusting the steering column while driving, or driving with the steering column unlocked, could cause the driver to lose control of the vehicle. Be sure the steering column is locked before driving your vehicle. Failure to follow this warning may result in severe injury or death.

GETTING STARTED

HEATED SEATS

Front Heated Seats

- The controls for the front heated seats are located on the center instrument panel area.
- Press the switch once to select High-level heating. Press the switch a second time to select Low-level heating. Press the switch a third time to shut the heating elements Off.
- If the High-level setting is selected, the system will automatically switch to Low-level after approximately 60 minutes. The Low-level setting will turn Off automatically after approximately 45 minutes.



WARNING!

- Persons who are unable to feel pain to the skin because of advanced age, chronic illness, diabetes, spinal cord injury, medication, alcohol use, exhaustion or other physical conditions must exercise care when using the seat heater. It may cause burns even at low temperatures, especially if used for long periods of time.
- Do not place anything on the seat that insulates against heat, such as a blanket or cushion. This may cause the seat heater to overheat. Sitting in a seat that has been overheated could cause serious burns due to the increased surface temperature of the seat.

OPERATING YOUR VEHICLE

ENGINE BREAK-IN RECOMMENDATIONS

- A long break-in period is not required for the engine and drivetrain (transmission and axle) in your vehicle.
- Drive moderately during the first 300 miles (500 km). After the initial 60 miles (100 km), speeds up to 50 or 55 mph (80 or 90 km/h) are desirable.
- While cruising, brief full-throttle acceleration within the limits of local traffic laws contributes to a good break-in. Wide-open throttle acceleration in low gear can be detrimental and should be avoided.
- The engine oil installed in the engine at the factory is a high-quality energy conserving type lubricant. Oil changes should be consistent with anticipated climate conditions under which vehicle operations will occur. For the recommended viscosity and quality grades, refer to “Maintaining Your Vehicle”.

NOTE:

A new engine may consume some oil during its first few thousand miles (kilometers) of operation. This should be considered a normal part of the break-in and not interpreted as an indication to an engine problem or malfunction.

CAUTION!



Never use Non-Detergent Oil or Straight Mineral Oil in the engine or damage may result.

OPERATING YOUR VEHICLE

TURN SIGNAL/LIGHTS LEVER



Headlights/Parking Lights

- Rotate the end of the lever to the first detent for parking lights  and to the second detent for headlights .

Instrument Panel Dimmer

- Rotate the center portion of the lever to the extreme bottom position to fully dim the instrument panel lights and prevent the interior lights from illuminating when a door is opened.
- Rotate the center portion of the lever up to increase the brightness of the instrument panel lights when the parking lights or headlights are on.
- Rotate the center portion of the lever upward to the next detent position to brighten the odometer and radio controls when the parking lights or headlights are on.
- Rotate the center portion of the lever upward to the last detent to turn on the interior lighting.

Flash To Pass

- Pull the lever toward you to activate the high beams. The high beams will remain on until the lever is released.

High Beam Operation

- Push the lever forward to activate the high beams.

NOTE:

For safe driving, turn off the high beams when oncoming traffic is present to prevent headlight glare and as a courtesy to other motorists.

Fog Lights

- Turn on the parking lights or low beam headlights and pull out the end of the lever.

Turn Signals/Lane Change Assist

- Tap the lever up or down once and the turn signal (right or left) will flash three times and automatically turn off.

OPERATING YOUR VEHICLE

WIPER/WASHER LEVER



Front Wipers

Intermittent, Low And High Operation

- Rotate the end of the lever to the first detent position for one of five intermittent settings, the second detent for low wiper operation and the third detent for high wiper operation.

Washer Operation

- Pull the lever toward you and hold for as long as spray is desired.

Mist

- Pull down on the lever and release when a single wipe is desired.

NOTE:

The mist feature does not activate the washer pump; therefore, no washer fluid will be sprayed on the windshield. The wash function must be activated in order to spray the windshield with washer fluid.

Rear Wiper

Wiper Operation

- Rotate the center portion of the lever forward to the first detent for rear wiper operation.

Washer Operation

- Rotate the center portion of the lever past the first detent to activate the rear washer.

OPERATING YOUR VEHICLE

SPEED CONTROL

- The Speed Control switches are located on the steering wheel.

Cruise ON/OFF

- Push the ON/OFF button to activate the Speed Control.
- CRUISE  will appear on the instrument cluster to indicate the Speed Control is on.
- Push the ON/OFF button a second time to turn the system off.

SET

- With the Speed Control on, push and release the SET – button to set a desired speed.



Accel/Decel

- Once a speed is set, pushing the RES + button once or the SET – button once will increase or decrease the set speed approximately 1 mph (2 km/h).
- Push and hold the RES + button to accelerate in 5 mph (8 km/h) increments or push and hold the SET – button to decelerate in 5 mph (8 km/h) increments; release the button to save the new set speed.

Resume

- To resume a previously selected set speed in memory, push the RES + button and release.

Cancel

- Push the CANCEL button, or apply the brakes to cancel the set speed and maintain the set speed memory.
- Push the ON/OFF button to turn the system off and erase the set speed memory.

WARNING!

- Leaving the Electronic Speed Control system on when not in use is dangerous. You could accidentally set the system or cause it to go faster than you want. You could lose control and have a collision. Always leave the Electronic Speed Control system off when you are not using it.
- Electronic Speed Control can be dangerous where the system cannot maintain a constant speed. Your vehicle could go too fast for the conditions, and you could lose control. A collision could be the result. Do not use Electronic Speed Control in heavy traffic or on roads that are winding, icy, snow-covered or slippery.

OPERATING YOUR VEHICLE

CONTINUOUSLY VARIABLE AUTOMATIC TRANSMISSION (CVT)

- While conventional automatic transmissions typically have 4, 5 or 6 speeds, the Continuously Variable Transmission (CVT) has an infinite number of speeds. This allows it to adjust to exactly the right ratio to optimize performance and fuel economy.
- Under hard acceleration, you may hear more engine noise than with a conventional transmission. The CVT may also occasionally feel like it is “shifting.” These characteristics are perfectly normal and contribute to the CVT's efficiency.

MANUAL CLIMATE CONTROLS



Air Recirculation

- Use Recirculation for maximum A/C operation.
- For window defogging, turn the Recirculation button off.
- Recirculation is allowed in floor mode and defrost/floor (mix mode) for approximately five minutes.

Heated Mirrors

- The mirrors are heated to melt frost or ice. This feature is activated whenever you turn on the rear window defroster.

OPERATING YOUR VEHICLE

AUTOMATIC TEMPERATURE CONTROLS (ATC)



Automatic Operation

- Turn the Mode and Blower Controls to the AUTO position.
- Select the desired temperature by rotating the Temperature Control.
- The system will maintain the set temperature automatically.

Air Conditioning (A/C)

- If the air conditioning button is pressed while in AUTO mode, the system will exit AUTO mode and stay in A/C. The mode and blower will go to the previous user setting.

Air Recirculation

- Use Recirculation for maximum A/C operation.
- For window defogging, turn the Recirculation button off.
- If the Recirculation button is pressed while in the AUTO mode, the indicator light may flash three times to indicate the cabin air is being controlled automatically.

Heated Mirrors

- The mirrors are heated to melt frost or ice. This feature is activated whenever you turn on the rear window defroster.

OPERATING YOUR VEHICLE

POWER SUNROOF

- The power sunroof switch is located on the overhead console.

Opening Sunroof

Express

- Press the switch rearward and release. The sunroof will fully open and stop automatically.

Closing Sunroof

Express

- Press the switch forward and release. The sunroof will close automatically from any position.

Manual Open/Close

- Press and hold the switch rearward to open or forward to close the sunroof. Any release of the switch will stop the movement, and the sunroof will remain in a partially open or closed position until the switch is pressed again.

Venting Sunroof

- Press and release the "VENT" button, and the sunroof will open to the vent position. This is called "Express Vent" and will occur regardless of sunroof position. During Express Vent operation, any movement of the switch will stop the sunroof.

Pinch Protection Feature

- This feature will detect an obstruction in the opening of the sunroof during Express Close operation. If an obstruction in the path of the sunroof is detected, the sunroof will automatically retract. Remove the obstruction if this occurs. Next, press the switch forward and release to Express Close.

NOTE:

If three consecutive sunroof close attempts result in Pinch Protect reversals, the fourth close attempt will be a Manual Close movement with Pinch Protect disabled.

OPERATING YOUR VEHICLE

WARNING!

- Never leave children unattended in a vehicle, and do not leave the key in the ignition switch (or leave the ignition of a vehicle equipped with Keyless Enter-N-Go™ in the ACC or ON/Run position). Occupants, particularly unattended children, can become entrapped by the power sunroof while operating the power sunroof switch. Such entrapment may result in serious injury or death.
- In a collision, there is a greater risk of being thrown from a vehicle with an open sunroof. You could also be severely injured or killed. Always fasten your seat belt properly and make sure all passengers are properly secured.
- Do not allow small children to operate the sunroof. Never allow your fingers, other body parts, or any object to project through the sunroof opening. Injury may result.

WIND BUFFETING

- Wind buffeting can be described as a helicopter-type percussion sound. If buffeting occurs with the rear windows open, adjust the front and rear windows together.
- If buffeting occurs with the sunroof open, adjust the sunroof opening, or adjust any window. This will minimize buffeting.

ELECTRONICS

YOUR VEHICLE'S SOUND SYSTEM



ELECTRONICS



USB Port on Radio – for copying files from a memory stick to your radio's hard drive.

Audio Jack – works with iPod® devices or other players with a headphones jack and a 3.5mm cable.

Volume Up

Change Audio Source

Volume Down

Steering Wheel Audio Controls (right rear surface of steering wheel)

USB Port (inside glove box) - when connected, allows you to control your iPod® or memory stick using the radio or steering wheel audio controls.

ELECTRONICS

Uconnect® 130

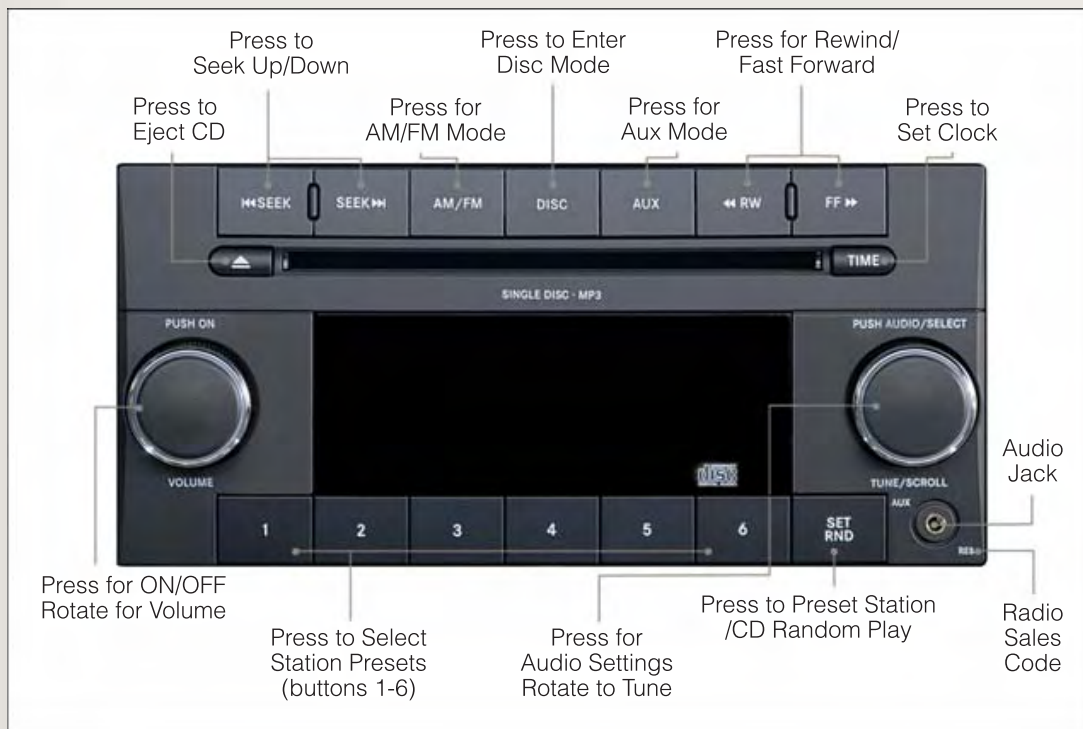

NOTE:

Your radio has many features that add to the comfort and convenience of you and your passengers. Some of these radio features should not be used when driving because they take your eyes from the road or your attention from driving.

Clock Setting

- Press and hold the “TIME” button until the hours blink; turn the “TUNE/SCROLL” control knob to set the hours.
- Press the “TUNE/SCROLL” control knob until the minutes begin to blink; turn the “TUNE/SCROLL” control knob to set the minutes.
- Press the “TUNE/SCROLL” control knob to save the time change.
- To exit, press any button/knob or wait five seconds.

Equalizer, Balance And Fade

- Press the “TUNE/SCROLL” control knob and BASS, MID, TREBLE, BALANCE and FADE will display. Rotate the “TUNE/SCROLL” control knob to select the desired setting.

Radio Operation

Seek Up/Down Buttons

- Press to seek through radio stations in AM or FM bands.
- Hold either button to bypass stations without stopping.

Store Radio Presets

- Press the “SET/RND” button once and SET 1 will show in the display. Then select button (1–6).
- A second station may be added to each push button. Press the “SET/RND” button twice and SET 2 will show in the display. Then select button (1–6).

CD/DISC Operation

Seek Up/Down Buttons

- Press to seek through CD tracks.
- Hold either button to bypass tracks without stopping.

SET/RND Button (Random Play)

- Press this button while the CD is playing to activate Random Play.
- This feature plays the selections on the CD in random order to provide an interesting change of pace.

Audio Jack Operation

- The AUX/Audio Jack provides a means to connect a portable audio device, such as an MP3 player, or an iPod®, to the vehicles sound system. This requires the use of a 3.5 mm stereo audio patch cable.
- Pressing the AUX button will change the mode to auxiliary device if the Audio Jack is connected, allowing the music from your portable device to play through the vehicle's speakers.
- The functions of the portable device are controlled using the device buttons, not the buttons on the radio. However, the volume may be controlled using the radio or portable device.

ELECTRONICS

Uconnect® 130 WITH SiriusXM SATELLITE RADIO

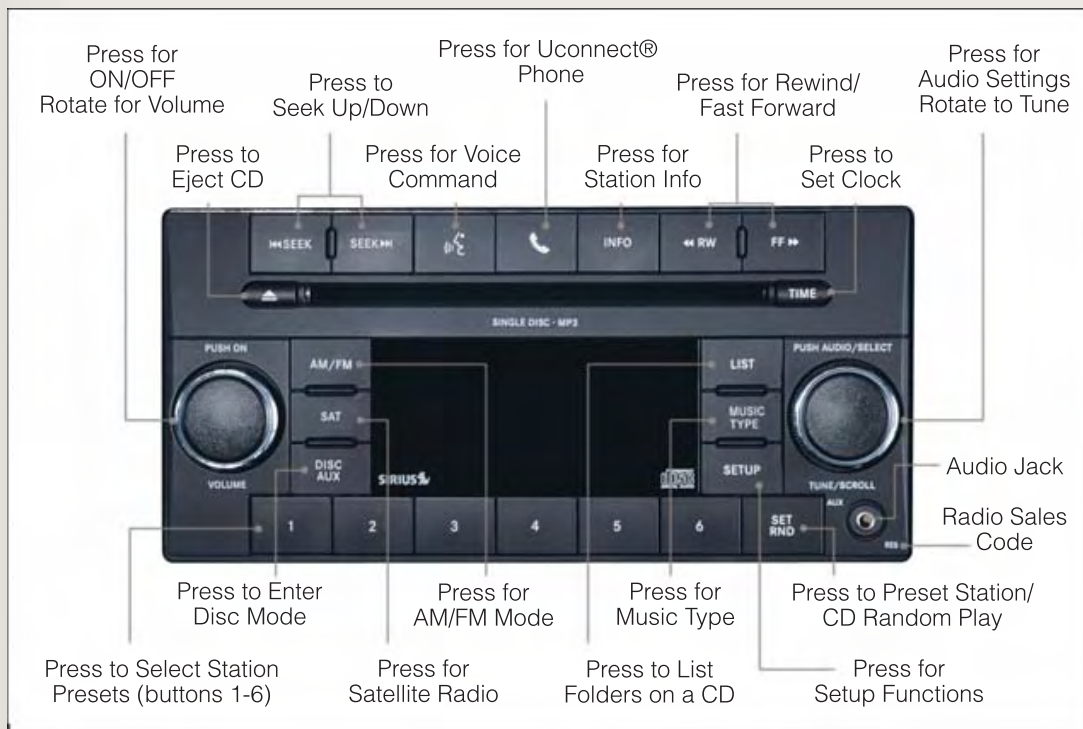

NOTE:

- Your radio may not be equipped with the Uconnect® Voice Command and Uconnect® Phone features. To determine if your radio has these features, press the Voice Command button on the radio. You will hear a voice prompt if you have the feature, or see a message on the radio stating “Uconnect Phone not available” if you do not.
- Your radio has many features that add to the comfort and convenience of you and your passengers. Some of these radio features should not be used when driving because they take your eyes from the road or your attention from driving.

Clock Setting

- Press and hold the “TIME” button until the hours blink; turn the “TUNE/ SCROLL” control knob to set the hours.
- Press the “TUNE/SCROLL” control knob until the minutes begin to blink; turn the “TUNE/SCROLL” control knob to set the minutes.
- Press the “TUNE/SCROLL” control knob to save the time change.
- To exit, press any button/knob or wait five seconds.

Equalizer, Balance And Fade

- Press the “TUNE/SCROLL” control knob and BASS, MID, TREBLE, BALANCE and FADE will display. Rotate the “TUNE/SCROLL” control knob to select the desired setting.

Radio Operation

Seek Up/Down Buttons

- Press to seek through radio stations in AM, FM, or SAT bands.
- Hold either button to bypass stations without stopping.

Store Radio Presets

- Press the “SET/RND” button once and SET 1 will show in the display. Then select button (1–6).
- A second station may be added to each push button. Press the “SET/RND” button twice and SET 2 will show in the display. Then select button (1–6).

Music Type

- Press the “MUSIC TYPE” button to activate this mode. Press the “MUSIC TYPE” button again or turn the “TUNE/SCROLL” control knob to select the desired music type (Adult Hits, Country, Jazz, Oldies, Rock, etc.).
- Once a music type is chosen and the icon is displayed, press either “SEEK” button and the radio will only search for stations with the selected music type.

NOTE:

The Music Type function only operates when in FM mode.

SETUP Button

- Pressing the “SETUP” button allows you to select between items that are available in that particular mode.
- Turn the “TUNE/SCROLL” control knob to scroll through the entries. Push the “AUDIO/SELECT” button to select an entry and make changes.

SiriusXM Satellite Radio

- SiriusXM Satellite Radio gives you over 130 channels, including 100% commercial-free music from nearly every genre, plus all your favorite sports, news, talk and entertainment channels—all with crystal clear, coast-to-coast coverage, all in one place and all at your fingertips.
- To access SiriusXM Satellite Radio, press the “SAT” hard-key.

ELECTRONICS

CD/DISC Operation

Seek Up/Down Buttons

- Press to seek through CD tracks.
- Hold either button to bypass tracks without stopping.

SET/RND Button (Random Play)

- Press this button while the CD is playing to activate Random Play.
- This feature plays the selections on the CD in random order to provide an interesting change of pace.

LIST Button

- Press the “LIST” button to bring up a list of all folders on the CD. Scroll up or down the list by turning the “TUNE/SCROLL” control knob.
- To select a folder from the list, press the “TUNE/SCROLL” control knob and the radio will begin playing the files contained in that folder.

Audio Jack Operation

- The AUX/Audio Jack provides a means to connect a portable audio device, such as an MP3 player, or an iPod®, to the vehicles sound system. This requires the use of a 3.5 mm stereo audio patch cable.
- Pressing the AUX button will change the mode to auxiliary device if the Audio Jack is connected, allowing the music from your portable device to play through the vehicle's speakers.
- The functions of the portable device are controlled using the device buttons, not the buttons on the radio. However, the volume may be controlled using the radio or portable device.

Uconnect® 230

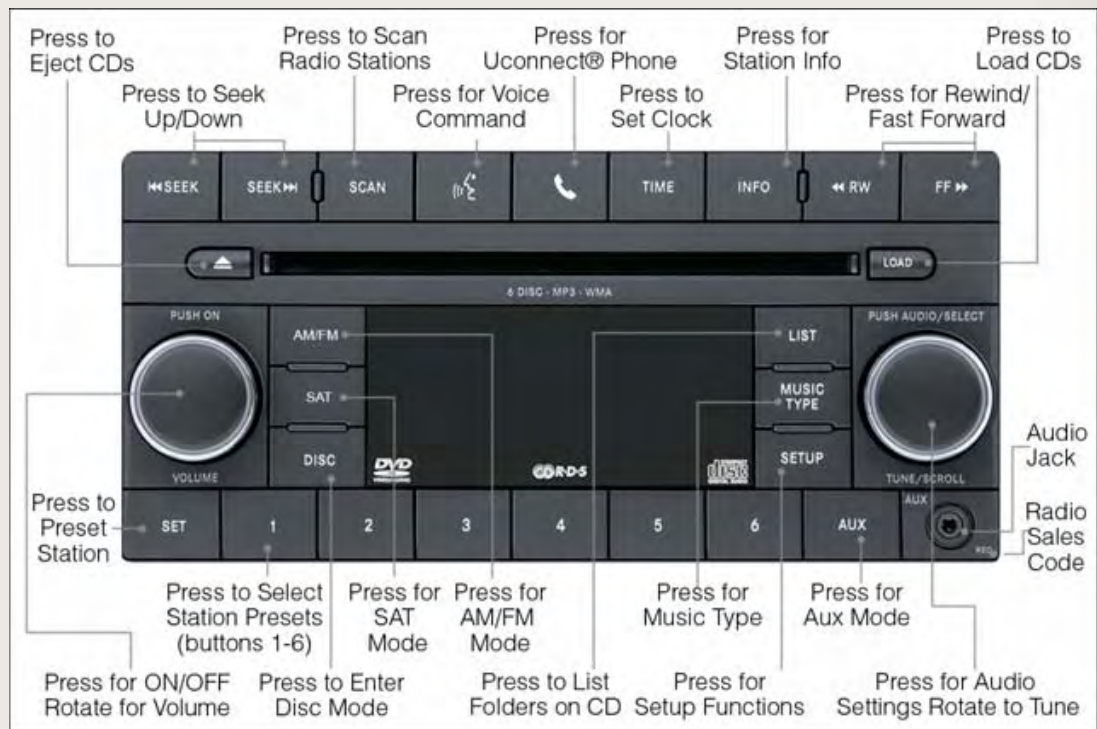

NOTE:

- Your radio may not be equipped with the Uconnect® Voice Command and Uconnect® Phone features. To determine if your radio has these features, press the Voice Command button on the radio. You will hear a voice prompt if you have the feature, or see a message on the radio stating “Uconnect Phone not available” if you do not.
- Your radio has many features that add to the comfort and convenience of you and your passengers. Some of these radio features should not be used when driving because they take your eyes from the road or your attention from driving.

Clock Setting

- Press and hold the “TIME” button until the hours blink; turn the “TUNE/ SCROLL” control knob to set the hours.
- Press the “TUNE/SCROLL” control knob until the minutes begin to blink; turn the “TUNE/SCROLL” control knob to set the minutes.
- Press the “TUNE/SCROLL” control knob to save the time change.
- To exit, press any button/knob or wait five seconds.

Equalizer, Balance And Fade

- Press the “TUNE/SCROLL” control knob and BASS, MID, TREBLE, BALANCE and FADE will display. Rotate the “TUNE/SCROLL” control knob to select the desired setting.

ELECTRONICS

Radio Operation

Seek Up/Down Buttons

- Press to seek through radio stations in AM, FM, or SAT bands.
- Hold either button to bypass stations without stopping.

Store Radio Presets

- Press the “SET” button once and SET 1 will show in the display. Then select button (1–6).
- A second station may be added to each push button. Press the “SET” button twice and SET 2 will show in the display. Then select button (1–6).

Music Type

- Press the “MUSIC TYPE” button to activate this mode. Press the “MUSIC TYPE” button again or turn the “TUNE/SCROLL” control knob to select the desired music type (Adult Hits, Country, Jazz, Oldies, Rock, etc.).
- Once a music type is chosen and the icon is displayed, press the SEEK button and the radio will only search for stations with the selected music type.

NOTE:

The Music Type function only operates when in FM mode.

SETUP Button

- Pressing the “SETUP” button allows you to select between items that are available in that particular mode.
- Turn the “TUNE/SCROLL” control knob to scroll through the entries. Push the “AUDIO/SELECT” button to select an entry and make changes.

SiriusXM Satellite Radio

- SiriusXM Satellite Radio gives you over 130 channels, including 100% commercial-free music from nearly every genre, plus all your favorite sports, news, talk and entertainment channels—all with crystal clear, coast-to-coast coverage, all in one place and all at your fingertips.
- To access SiriusXM Satellite Radio, press the “SAT” hard-key.

CD/DISC Operation

Seek Up/Down Buttons

- Press to seek through CD tracks.
- Hold either button to bypass tracks without stopping.

LIST Button

- Press the “LIST” button to bring up a list of all folders on the CD. Scroll up or down the list by turning the “TUNE/SCROLL” control knob.
- To select a folder from the list, press the “TUNE/SCROLL” control knob and the radio will begin playing the files contained in that folder.

How To Load Multiple CDs/DVDs

- Press the “LOAD” button and then press the button with the corresponding number (1–6) where the CD is being loaded. The radio will display “PLEASE WAIT” and prompt when to “INSERT DISC”.
- After the radio displays “INSERT DISC”, insert the CD into the player. The radio display will show “LOADING DISC” when the disc is loading and “READING DISC” when the radio is reading the disc.
- Press the eject button and then the corresponding number (1–6) to eject the desired disc.

Audio Jack Operation

- The AUX/Audio Jack provides a means to connect a portable audio device, such as an MP3 player, or an iPod®, to the vehicles sound system. This requires the use of a 3.5 mm stereo audio patch cable.
- Pressing the AUX button will change the mode to auxiliary device if the Audio Jack is connected, allowing the music from your portable device to play through the vehicle's speakers.
- The functions of the portable device are controlled using the device buttons, not the buttons on the radio. However, the volume may be controlled using the radio or portable device.

ELECTRONICS

Uconnect® 430/430N



NOTE:

- Your radio may not be equipped with the Uconnect® Voice Command and Uconnect® Phone features. To determine if your radio has these features, press the Voice Command button on the radio. You will hear a voice prompt if you have the feature, or see a message on the radio stating “Uconnect Phone not available” if you do not.
- Your radio has many features that add to the comfort and convenience of you and your passengers. Some of these radio features should not be used when driving because they take your eyes from the road or your attention from driving.

Clock Setting

- Turn the radio on, then touch the screen where the time is displayed.
- Touch the “USER CLOCK” soft-key (Navigation radio only).
- To adjust the hours, touch either the “HOUR FORWARD” or “HOUR BACKWARD” soft-key.
- To adjust the minutes, touch either the “MINUTE FORWARD” or “MINUTE BACKWARD” soft-key.
- To save the new time setting, touch the screen where the word “Save” is displayed.

Menu

- Press the “MENU” hard-key to access the System Setup menu and the My Files menu.
- Press the “MENU” hard-key in an active mode (SAT, CD, AUX, etc.) to change mode specific settings.

Equalizer, Balance And Fade

Audio Control Menu

- Press the “AUDIO” hard-key on the right side of the radio.
- Use either the arrow soft-keys or the cross-hair on the screen to change Balance and Fade. The “CENTER” soft-key resets the settings.
- Touch the “Equalizer” soft-key and use either the arrow soft-keys or the sliders on the screen to adjust BASS, MID, and/or TREBLE.



Display Settings

- Press the “MENU” hard-key and touch the “Display Settings” soft-key to access the Display Settings menu.
- Select the “Daytime Colors” soft-key to switch to manual daytime mode and to adjust the brightness of the display using daytime colors.
- Select the “Nighttime Colors” soft-key to switch to manual nighttime mode and to adjust the brightness of the display using nighttime colors.
- Select the “Auto Color Mode” soft-key to switch to automatic daytime/nighttime mode and to control the brightness of the display using the dimmer switch of the vehicle.
- Touch the “EXIT” soft-key to save your settings.



ELECTRONICS

Radio Operation

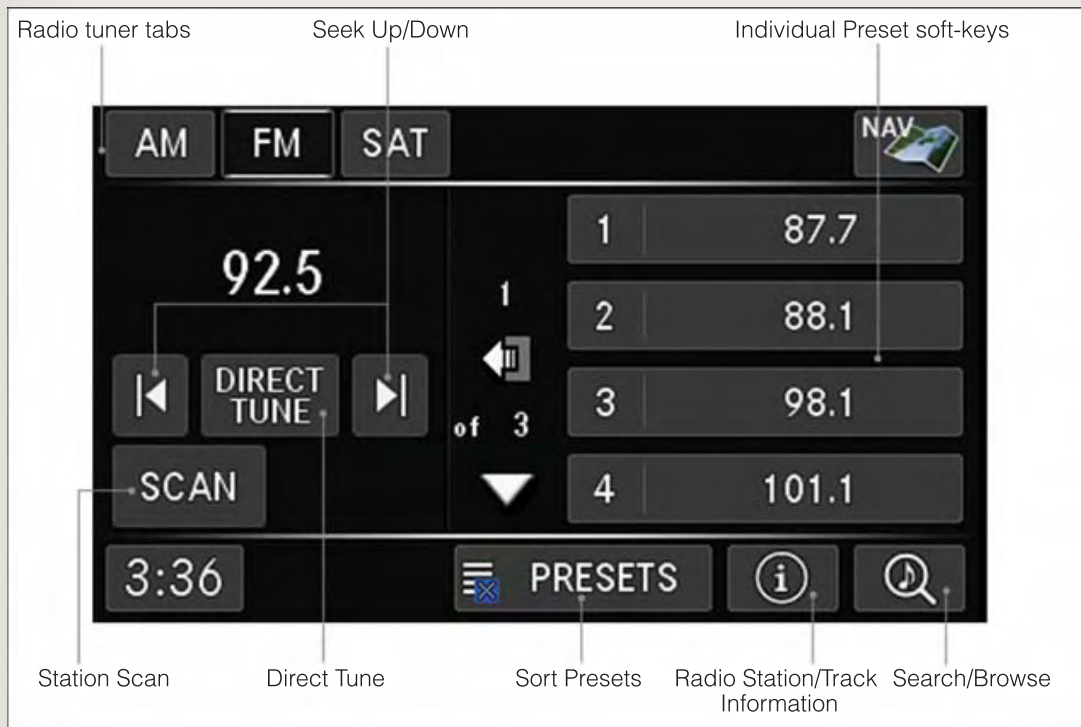

- To access Radio Mode, touch the “RADIO” hard-key on the left side of the faceplate, then touch the “AM,” “FM” or “SAT” soft-key at the top of the screen to select the band.

Seek Up/Seek Down

- Press the “Seek Up” or “Seek Down” soft-keys to seek through radio stations in AM, FM, or SAT bands. Hold either Seek to bypass stations without stopping.

Store Radio Presets

- Select the radio band by touching either the “AM,” “FM,” or “SAT” soft-key.
- Find the station to store by either pressing the “Seek Up” or “Seek Down” soft-keys, touching the “SCAN” soft-key, or by using the “DIRECT TUNE” soft-key.
- Once the station is found, touch and hold one of the “PRESET” soft-keys in the list to the right, until you hear a confirmation beep.

NOTE:

If the Presets are not visible on the right side of the screen, press the “Presets” soft-key.

CD/DVD Disc Operation

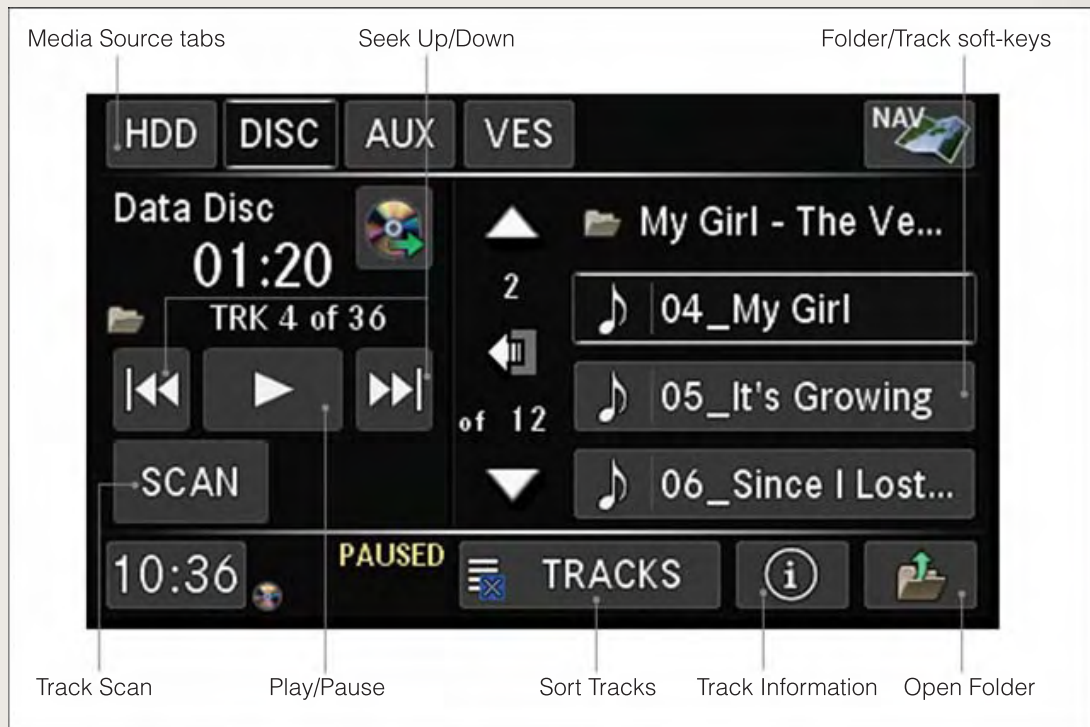

- Press the “MEDIA” hard key to display the media source tabs at the top of the screen. Select the source by touching the “HDD,” “DISC,” or “AUX” media source soft-key tab.

NOTE:

Your Touch-Screen Radio will usually automatically switch to the appropriate mode when something is first connected or inserted into the system.

Insert a CD/DVD Disc

- To insert a disc, press the “LOAD” hard-key.
- With the printed side upwards, insert the disc into the disc slot of the radio. The radio pulls the disc in automatically and closes the flip screen. The radio selects the appropriate mode after the disc is recognized, and starts playing the first track. The display shows “Reading...” during this process.

Seek Up/Seek Down

- Press the “Seek Up” or “Seek Down” soft-keys to seek through tracks in Disc Mode. Hold either Seek to bypass tracks without stopping.

ELECTRONICS

Audio Jack Operation

- The AUX/Audio Jack provides a means to connect a portable audio device, such as an MP3 player or an iPod®, to the vehicle's sound system. This requires the use of a 3.5 mm stereo audio patch cable.
- Pressing the "MEDIA" hard-key and then the "AUX" soft-key to change the mode to auxiliary device if the Audio Jack is connected, allowing the music from your portable device to play through the vehicle's speakers.
- The functions of the portable device are controlled using the device itself, not the buttons on the radio. However, the volume may be controlled using the radio or portable device.

Hard Disk Drive (HDD) Operation

- The Hard Disk Drive (HDD) mode gives you access to the audio files on the internal hard disk drive. It functions similar to a CD player, with the exception that the internal HDD can hold more tracks.
- It is also possible to import display pictures to the internal hard disk drive. The pictures can be displayed on the right half of the radio screen.
- Before using the HDD mode, you will need to copy songs and pictures to the internal hard drive. Songs and pictures can be added to the hard drive by using a CD or USB device (e.g. thumb drive or memory stick).

NOTE:

HDD supports only .jpg/JPEG formats for photos.

NOTE:

WMA/MP3 Files and Selective Songs from a CD can also be added to the HDD. See the Uconnect® 430/430N User's Manual for more information.

Copying Music From CD

- Press the "LOAD" hard-key.
- Insert a disc, then press the "MY FILES" hard-key and then select "MY MUSIC soft-key."
- Touch the "Add Music Files to HDD" soft-key, then touch the "Disc" soft-key in the next screen to start the process.

NOTE:

- You might need to select the folder or title depending on the CD, then press "DONE" to start the copy process.
- The copy progress is shown in the lower left corner of the screen.

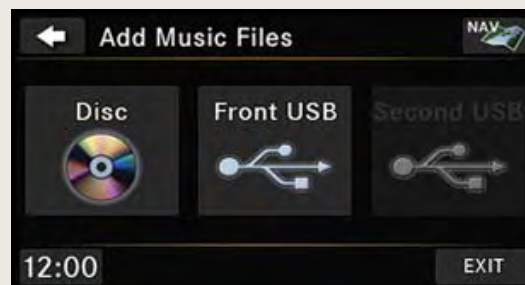

Copying Music From USB

- The USB port on the radio face plate allows you to copy files to your hard drive. To access, lift up on the cover.
- Insert a USB device (e.g. thumb drive or memory stick), then select “MY MUSIC soft-key.”
- Touch the “Add Music Files to HDD” soft-key, then touch the “Front USB” soft-key in the next screen.
- Select the folders or titles you would like to copy, then touch the “DONE” soft-key to start the copy process.

NOTE:

The copy progress is shown in the lower left corner of the screen.



Copying Pictures To The HDD

- Insert either a CD or a USB device containing your pictures in JPEG format.
- Press the “MY FILES” hard-key.
- Touch the “My Pictures” soft-key to get an overview of the currently stored images, then touch the “Add” soft-key.
- Touch the “Disc” or “USB” soft-key, then select the folders or pictures you wish to copy to the HDD. Use the “PAGE” soft-keys to page through the list of pictures.
- Touch the desired pictures or press the “All” soft-key for all pictures. Confirm your selections by touching the “SAVE” soft-key.

NOTE:

The copy progress is shown in the lower left corner of the screen.



Display A Picture On The Radio Screen

- Once the import is complete, the pictures will then be available in the “MY PICTURES” screen.
- Press the “MY FILES” hard-key, then touch the “My Pictures” soft-key. Touch the desired picture, then touch the “Set as Picture View” soft-key and then touch the “Exit” soft-key. Lastly press the “MENU” hard-key and then touch the “Picture View” soft-key to display the chosen picture on the radio screen.

ELECTRONICS

NOTE:

- A check mark in the My Pictures screen indicates the currently used picture.
- You can also delete pictures by touching the “Delete” soft-key.

Playing Music From The HDD

- Press the “MEDIA” hard key to display the media source tabs at the top of the screen. Touch the “HDD” soft-key tab. Touch the desired track soft-key to play or touch the “SEARCH/BROWSE” soft-key to search by artist, by album, by song, by genre, from a folder, or from Favorites.



Cleaning Your Touch-Screen Radio

- Do not spray any liquid or caustic chemicals directly on the screen. Use a clean and dry micro fiber lens cleaning cloth to clean the touch-screen.
- If necessary, use a lint-free cloth dampened with a cleaning solution such as isopropyl alcohol or an isopropyl alcohol and water solution ratio of 50:50. Always follow the solvent manufacturer's precautions and directions.

ELECTRONICS

Garmin® Navigation

- Uconnect® 430N integrates Garmin's consumer-friendly navigation into your vehicle. Garmin® Navigation includes a database with over six million points of interest.
- Touch the "NAV" soft-key in the upper right corner of the screen to access the Navigation system.



Changing the Navigation Voice Prompt Volume

1. Program a destination.
2. While traveling on your route, touch the upper left area of the map screen where your next turn is displayed.
3. The Navigation system will then repeat the distance to your next turn.
4. While the Navigation system is speaking, use the ON/OFF VOLUME rotary knob to adjust the volume to a comfortable level. Please note the volume setting for Navigation Voice Prompt is different than the audio system.

NOTE:

For your own safety and the safety of others, it is not possible to use certain features while the vehicle is in motion.

Main Navigation Menu

Finding Points Of Interest

- From the main Navigation menu, touch the "Where To?" soft-key, then touch the "Points of Interest" soft-key.
- Select a Category, then a subcategory, if necessary.
- Select your destination and touch the "Go" soft-key.

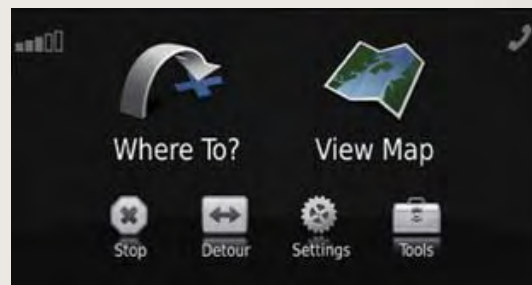

ELECTRONICS

Finding A Place By Spelling The Name

- From the Main Navigation Menu touch the “Where To?” soft-key. Next, touch the “Points of Interest” soft-key then touch the “Spell Name” soft-key.
- Enter the name of your destination.
- Touch the “Done” soft-key.
- Select your destination and touch the “Go” soft-key.

Entering A Destination Address

- From the main Navigation menu touch the “Where To?” soft-key, then touch the “Address” soft-key.
- Follow the on-screen prompts to enter the address then touch the “Go” soft-key.

Searching Near Another Location

- From the main Navigation menu touch the “Where To?” soft-key. Next, touch a destination then touch the “Near” soft-key.
- Select an option from the available choices.

Setting Your Home Location

- From the main Navigation menu touch the “Where To?” soft-key, then touch the “Go Home” soft-key.
- You may enter your address directly, use your current location as your home address, or choose from recently found locations.

Edit Home Location

- From the main Navigation menu touch the “Where To?” soft-key, then touch the “Favorites” soft-key.
- Next touch the location you would like to edit, touch the “Press for More” soft-key, then the “Edit” soft-key.

Go Home

- A Home location must be saved in the system. From the Main Navigation menu, touch the “Where To?” soft-key, then touch the “Go Home” soft-key.

Following Your Route

- Your route is marked with a magenta line on the map. If you depart from the original route, your route is recalculated. A speed limit icon could appear as you travel on major roadways.

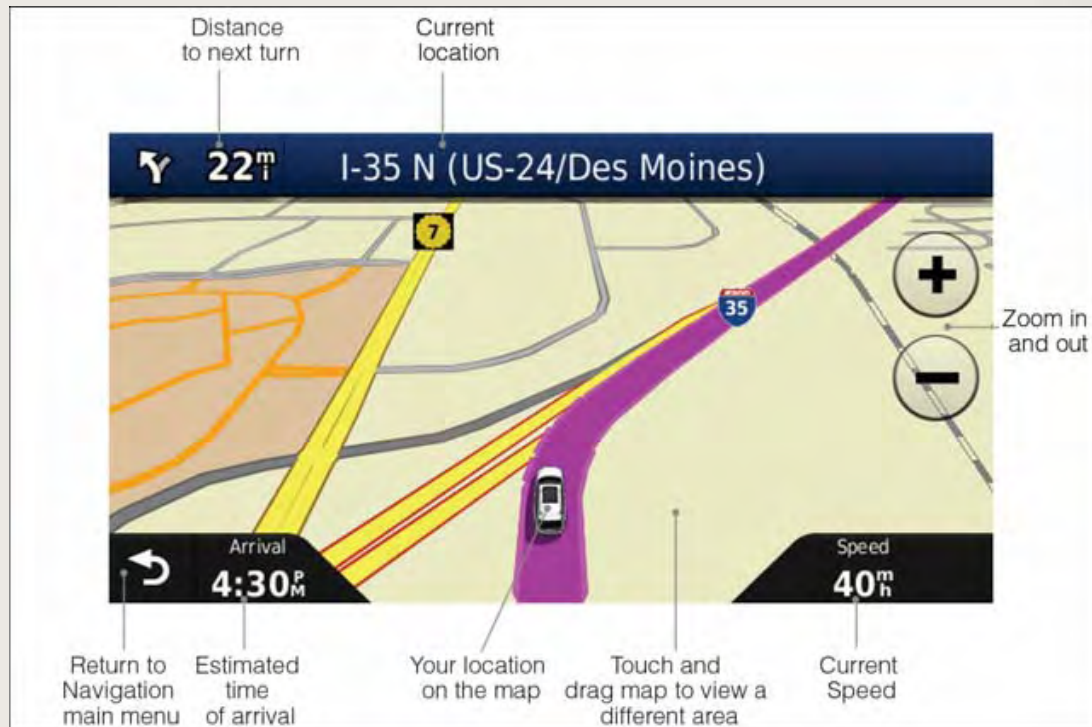

Adding A Via Point

- To add a stop between the current location and the end destination (Via Point) you must be navigating a route.
- Touch the “back arrow icon” multiple times to return to the Main Navigation menu.
- Touch the “Where To?” soft-key, then search for the additional stop. Then select the Via Point you wish to add from the given search results.
- Touch the “Go” soft-key, then touch the “Add to Current Route” soft-key.

Taking A Detour

- To take a detour you must be navigating a route.
- Touch the “back arrow icon” soft-key multiple times to return to the Main Navigation menu.
- Touch the “Detour” soft-key.

NOTE:

If the route you are currently taking is the only reasonable option, the device might not calculate a detour.

ELECTRONICS

Acquiring Satellites

- The GPS Satellite strength bars indicate the strength of your satellite reception.
- Acquiring satellite signals can take a few minutes. When at least one of the bars is green, your device has acquired satellite signals.
- You may experience delays receiving satellite signals when in areas with an obstructed view to the sky, such as garages, tunnels, or large cities with tall buildings.

SiriusXM SATELLITE RADIO/TRAVEL LINK

- SiriusXM Travel Link requires a subscription, sold separately after the 1 year trial subscription included with your vehicle purchase.
- SiriusXM Travel Link is only available in the United States.
- The following describes features that are available when in SiriusXM Satellite Radio mode.
- To access SiriusXM Satellite Radio, press the “RADIO/MEDIA” or “RADIO” and then touch the “SAT” soft-key tab.

Info

- Touch the “i” soft-key to view detailed information about the current Sirius XM Satellite channel.

SiriusXM Parental Controls

- SiriusXM offers the option to permanently block selected channels. Call 1-888-539-7474 and request the Family Package.
- Uconnect® 430/430N and 730N: Press the “MENU” hard-key while in SiriusXM Satellite Radio Mode, then touch the “Channel Lock” to enable and/or disable desired channels. The SEEK and SCAN function will then only display channels without Channel lock.

Search/Browse

- Touch the “magnifying glass” soft-key to search/browse the SiriusXM channel listing by Favorites and Categories such as Song, Artist and Channel Name. The Search/Browse also allows you manage your Favorites.

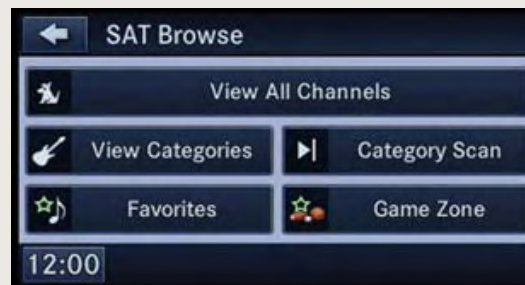

SiriusXM Satellite Radio Favorites (SAT Favorites)

- You can save 50 favorite songs and 50 favorite artists.
- Touch the “add favorite” soft-key to add either the song or the artist of the currently playing program to the SAT Favorites list. The favorite star will appear in the upper right corner, below the SAT soft-key.
- You will see a favorite star indicator in the upper right side of the screen below the SAT soft-key and a pop up will alert you that a favorite song or artist is currently playing on one of the SiriusXM satellite radio channels.

NOTE:

Refer to your Uconnect® 730N or 430/430N User's Manual for more information.

Display SAT Favorites List

- Touch the “Search/Browse” soft-key and select “Favorites” from the SAT Browse screen.
- Touch the desired favorites soft-key to switch the SAT tuner to the corresponding channel.
- You may use the “LIST” soft-key to toggle between:
 - Favorite Songs.
 - Favorite Artists.
 - Currently playing favorites.

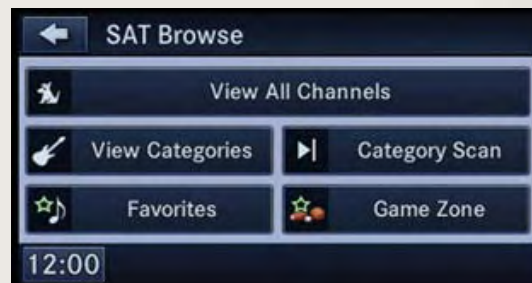

ELECTRONICS

Replay

- While you are in SAT mode, you can replay 44 minutes of the current SiriusXM channel (when the channel is changed, this audio buffer is erased). Press the REPLAY button to listen to the stored audio.
- You can touch the on-screen controls to pause and rewind audio playback, touch the SCAN button to preview each of the tracks stored in the buffer, or select a track from the list.
- The time displayed below the bar indicates how much time is present between the current buffer play position and the live broadcast.



Replay Option	Option Description
Play/Pause	Touch to Pause content playback. Touch Pause/Play again to resume playback.
Rewind/RW	Rewinds the channel content in steps of five seconds. Touch and hold to rewind continuously, then release to begin playing content at that point.
Fast Forward/FW	Forwards the content, and works similarly to Rewind/RW. However, Fast Forward/FW can only be used when content has been previously rewind.
Replay Time	Displays the amount of time in the upper center of the screen by which your content lags the Live channel.
Live	Resumes playback of Live content at any time while replaying rewind content.

ELECTRONICS

SiriusXM Travel Link (Uconnect® 730N & Uconnect® 430N Only)

NOTE:

- SiriusXM Travel Link requires a subscription, sold separately after the 1 year trial subscription included with your vehicle purchase.
- SiriusXM Travel Link is only available in the United States.
- SiriusXM Travel Link brings a wealth of useful information into your vehicle and right to your fingertips.
- To access Travel Link, press the MENU hard-key, then the Travel Link soft-key.



1 – Favorites	View and store your favorite location, theater and sport teams for quick access.
2 – Forecast	View detailed weather conditions, forecasts and ski/snowboarding conditions at resorts.
3 – Ski Info	View ski and snowboarding conditions at ski resorts.
4 – Fuel Prices	View detailed price information for fuel stations.
5 – Movies	View information on movies that are playing at theaters.
6 – Sports	View sports scores and upcoming events for all major sports.

ELECTRONICS

STEERING WHEEL AUDIO CONTROLS

- The steering wheel audio controls are located on the rear surface of the steering wheel.

Right Switch

- Press the switch up or down to increase or decrease the volume.
- Press the button in the center to change modes AM/FM/CD/SAT.



Left Switch

- Press the switch up or down to search for the next listenable station or select the next or previous CD track.
- Press the button in the center to select the next preset station (radio) or to change CDs if equipped with a CD Changer.

iPod®/USB/MP3 CONTROL

- There are many ways to play music from iPod®/MP3 players or USB devices through your vehicle's sound system.
- The remote USB port, located within the front storage area, allows you to plug an iPod® into the vehicle's sound system.
- Non-Touch-Screen Radios: To hear audio from devices connected to the USB port, press the "AUX" button on the radio faceplate.
- Touch-Screen Radios: To hear audio from devices connected to the USB port, press the "MEDIA" hard-key, then touch the "AUX" or "iPod®" soft-key.
- When connected to this feature:
 - The iPod® can be controlled using the radio buttons to Play, Browse, and List the iPod® or external devices contents.
 - The iPod® battery charges when plugged into the USB port (if supported by the specific audio device).
 - Compatible iPod® devices may also be controllable using voice commands. Refer to the Owner's Manual on the DVD for details.



NOTE:

The USB port supports certain Mini, Classic, Nano, Touch, and iPhone® devices. The USB port also supports playing music from compatible external USB Mass Storage Class memory devices. For supported audio file formats, refer to the USB Port section in the Owner's Manual on the DVD. Refer to www.UconnectPhone.com website for a list of tested iPod®s. Some iPod® software versions may not fully support the USB port features. Please visit Apple's website for iPod® software updates.

WARNING!

Do not plug in or remove the iPod® or external device while driving. Failure to follow this warning could result in a collision.

Uconnect® Phone

- To determine if your vehicle is equipped with Uconnect® Phone, press the “Uconnect® Phone” button  located on the radio faceplate. If your vehicle has this feature, you will hear a voice prompt. If not, you will see a message on the radio “Uconnect phone not available”.
- The Uconnect® Phone is a voice-activated, hands-free, in-vehicle communications system with Voice Command Capability (see Voice Command section).

NOTE:

To access the tutorial, press the “Uconnect® Phone” button . After the BEEP, say “tutorial.” Press any hard-key/button or touch the display (Touch-Screen radio) to cancel the “tutorial”.

- The Uconnect® Phone allows you to dial a phone number with your mobile phone using simple voice commands.
- Refer to your vehicle Owner's Manual on the DVD for further details.

NOTE:

The Uconnect® Phone requires a mobile phone equipped with the Bluetooth® Hands-Free Profile, Version 1.0 or higher. For Uconnect® Customer Support: U.S. residents - visit www.UconnectPhone.com or call 1-877-855-8400. Canadian Residents - call, 1-800-465-2001 (English) or 1-800-387-9983 (French). This site will provide specific instructions based on the type of mobile phone being paired.

ELECTRONICS

Phone Pairing

NOTE:

- Pairing is a one-time initial setup before using the phone.
- Prior to starting the pairing procedure ensure all additional phones within the vehicle have their Bluetooth® disabled.
- The Uconnect® Phone requires a mobile phone equipped with the Bluetooth® Hands-Free Profile, Version 1.0 or higher. For Uconnect® customer support: U.S. residents - visit www.UconnectPhone.com or call 1-877-855-8400. Canadian Residents - call 1-800-465-2001 (English) or 1-800-387-9983 (French). This site will provide specific instructions based on the type of mobile phone being paired.
- Press the “Phone”  button to begin.
- Wait for the “ready” prompt and BEEP.
- After the BEEP, say ”setup” or “Uconnect device setup”.
- After the BEEP, say “device pairing”.
- After the BEEP, say “pair a device”.
- Follow the audible prompts.
- You will be asked to say a four-digit Personal Identification Number (PIN), which you will later need to enter into your mobile phone. You can say any four-digit PIN. You will not need to remember this PIN after the initial pairing process.
- You will then be prompted to give the phone pairing a name (each phone paired should have a unique name).
- Next you will be asked to give this new pairing a priority of 1 thru 7 (up to seven phones may be paired); 1 is the highest and 7 is the lowest priority. The system will only connect to the highest priority phone that exists within the proximity of the vehicle.
- You will then need to start the pairing procedure on your cell phone. Follow the Bluetooth® instructions in your cell phone Owner's Manual to complete the phone pairing setup.



Phonebook

Phonebook Download – Automatic Phonebook Transfer From Mobile Phone

- If equipped and specifically supported by your phone, Uconnect® Phone automatically downloads names (text names) and number entries from your mobile phone's phonebook. Specific Bluetooth® Phones with Phone Book Access Profile may support this feature. Automatic Transfer is indicated by a green arrow at the bottom of the screen. See www.UconnectPhone.com for supported phones.
- Automatic download and update, if supported, begins as soon as the Bluetooth® wireless phone connection is made to the Uconnect® Phone. For example, after you start the vehicle.

NOTE:

The mobile phone may require authorization prior to download.





- A maximum of 1000 entries per phone will be downloaded and updated every time a phone is connected to the Uconnect® Phone.
- Depending on the maximum number of entries downloaded, there may be a short delay before the latest downloaded names can be used. Until then, if available, the previously downloaded phonebook is available for use.
- Only the phonebook of the currently connected mobile phone is accessible.
- Only the mobile phone's phonebook is downloaded. The SIM card phonebook is not part of the Mobile phonebook.
- This downloaded phonebook cannot be edited or deleted on the Uconnect® Phone. These can only be edited on the mobile phone. The changes are transferred and updated to Uconnect® Phone on the next phone connection.

Making A Phone Call

- Press the "Phone" button .
- After the BEEP, say "dial" (or "call" a name).
- After the BEEP, say number (or name).

ELECTRONICS

Receiving A Call – Accept (And End)

- When an incoming call rings/is announced on Uconnect®, press the Phone button .
- To end a call, press the Phone button .

Mute (Or Unmute) Microphone During Call

- During a call, press the “Voice Command” button  VR .
- After the BEEP, say “mute” (or “mute off”).

Transfer Ongoing Call Between Handset And Vehicle

- During a call, press the “Voice Command” button  VR .
- After the BEEP, say “transfer call”.

Changing The Volume



- Start a dialogue by pressing the “Phone” button , then adjust the volume during a normal call.
- Use the radio ON/OFF VOLUME rotary knob to adjust the volume to a comfortable level while the Uconnect® system is speaking. Please note the volume setting for Uconnect® is different than the audio system.

WARNING!

- Any voice commanded system should be used only in safe driving conditions following applicable laws regarding phone use. Your attention should be focused on safely operating the vehicle. Failure to do so may result in a collision causing you and others to be severely injured or killed.
- In an emergency, to use Uconnect® Phone, your mobile phone must be:
 - turned on,
 - paired to Uconnect® Phone,
 - and have network coverage.

Uconnect® VOICE COMMAND

Voice Command Operation

- The Uconnect® Voice Command system allows you to control your AM, FM radio, satellite radio, disc player, HDD, Uconnect® Phone, a memo recorder, and supported portable media devices.
- When you press the “Voice Command” button  VR located on the radio faceplate or steering wheel, you will hear a beep. The beep is your signal to give a command. If you do not say a command within a few seconds, the system will present you with a list of options. If you ever wish to interrupt the system while it lists options, press the “Voice Command” button  VR , listen for the BEEP, and say your command.

NOTE:

Visit <http://www.driveuconnect.com/features/voiceCommand/> for more info on which voice command features apply to your vehicle



- Start a dialogue by pressing the “Voice Command” button  VR , you will hear a beep. The beep is your signal to give a command. Below are a list of voice commands for each of the different modes.



Common Voice Commands (Examples)

While In:	Voice Command Example:
Main Menu	“Radio AM” (to switch to the AM radio mode)
	“Radio FM” (to switch to the FM radio mode)
	“Satellite Radio” (to switch to the Satellite radio mode)
	“Disc” (to switch to the disc mode)
	“USB” (to switch to the USB mode)
	“Bluetooth Streaming” (to switch to the Bluetooth Streaming mode)
	“Memo” (to switch to the memo recorder)
	“System Setup” (to switch to system setup)

ELECTRONICS

While In:	Voice Command Example:
Radio Mode	“Frequency” (to change the frequency)
	“Next Station” (to select the next station)
	“Previous Station” (to select the previous station)
	“Radio Menu” (to switch to the radio menu)
	“Main Menu” (to switch to the main menu)
SiriusXM Satellite Radio Mode	“Channel Number” (to change the channel by its spoken number)
	“Next Channel” (to select the next channel)
	“Previous Channel” (to select the previous channel)
	“List Channel” (to hear a list of available channels)
	“Channel Name” (to change the channel by its spoken name)
	“Select Name” (to say the name of a channel)
	“Radio Menu” (to switch to the radio menu)
	“Main Menu” (to switch to the main menu)
Disc Mode	“Track” (#) (to change the track)
	“Next Track” (to play the next track)
	“Previous Track” (to play the previous track)
	“Main Menu” (to switch to the main menu)
Memo Mode	To switch to the voice recorder mode, say “Memo”. The following are common voice commands for this mode: “New Memo” (to record a new memo) — During the recording, you may press the Voice Command button  VR to stop recording. You proceed by saying one of the following commands:
	— “Save” (to save the memo)
	— “Continue” (to continue recording)
	— “Delete” (to delete the recording)
	— “Play Memos” (to play previously recorded memos) — During the playback you may press the Voice Command button  VR to stop playing memos. You proceed by saying one of the following commands:
	— “Repeat” (to repeat a memo)
	— “Next” (to play the next memo)
	— “Previous” (to play the previous memo)
	— “Delete” (to delete a memo)
	— “Delete All” (to delete all memos)

Voice Text Reply

- If equipped with Uconnect® Voice Command, your Uconnect® 430N, 730N & 731N radios may be able to play incoming Short Message Service (SMS) messages (text messages) through the vehicle's sound system.
- It also allows you to respond by selecting from various pre-defined phrases.
- Not all phones are compatible with this feature. Refer to the phone compatibility list at www.UconnectPhone.com. Connected mobile phones must be bluetooth-compatible, and paired with your radio.
- Press the “Voice Command” button  VR and after the BEEP, say “SMS” to get started.

NOTE:

To access the tutorial, press the “Voice Command” button  VR . After the BEEP, say “tutorial”. Press any hard-key/button or touch the display (Touch-Screen radio) to cancel the tutorial.

WARNING!

Any voice commanded system should be used only in safe driving conditions following applicable laws regarding phone use. Your attention should be focused on safely operating the vehicle. Failure to do so may result in a collision causing you and others to be severely injured or killed.

Bluetooth® STREAMING AUDIO

- If equipped with Uconnect® Voice Command, your Bluetooth-equipped iPod® devices, cell phones or other media players, may also be able to stream music to your vehicle's speakers. Your connected device must be Bluetooth-compatible, and paired with your radio (see Uconnect® Phone for pairing instructions).
- Non-Touch-Screen Radios: Press the “AUX” button on the radio faceplate until “BT” or “Audio Streaming” is displayed on the radio screen.
- Touch-Screen-Radios: Press the “RADIO/MEDIA” or “MEDIA” hard-key and then touch the “AUX” soft-key tab.



ELECTRONICS

ELECTRONIC VEHICLE INFORMATION CENTER (EVIC)

- The EVIC features a driver interactive display that is located in the instrument cluster. Pressing the controls on the steering wheel allows the driver to select vehicle information and Personal Settings. For additional information, refer to Programmable Features in this guide.



- Press and release the MENU button and the mode displayed will change between Compass/Temperature, Trip, System Status, and Personal settings.
- Press the DOWN ▼ button to scroll through sub menus (i.e., Trip Functions, Avg. Fuel Economy, DTE, Elapsed Time, and Units).
- Press and release the COMPASS Ⓝ button for instant access to the Compass/Temperature screens.
- Press the SELECT ► button to RESET Trip Functions and change Personal Settings.

Compass Calibration

- This compass is self-calibrating, which eliminates the need to set the compass manually. When the vehicle is new, the compass may appear erratic and the EVIC will display “CAL” until the compass is calibrated.
- You may also calibrate the compass by completing one or more 360 degree turns (in an area free from large metal or metallic objects) until the “CAL” message displayed in the EVIC turns off. The compass will now function normally.

PROGRAMMABLE FEATURES

Electronic Vehicle Information Center (EVIC)

- The EVIC can be used to program the following Personal Settings. Press and release the MENU button until Personal Settings displays, then press the DOWN button ▼ to scroll through the settings. Press the SELECT button ► to change the setting.
 - Language
 - Auto Unlock On Exit
 - RKE Unlock Driver's Door 1st
 - Flash Lamps With Lock
 - Sound Horn With Lock
 - Headlamp Off Delay
 - Key Off Power Delay
 - Illuminated Approach
 - Hill Start Assist (HSA)
 - Display Units In
 - Confirmation of Voice Commands
 - Automatic Compass Calibration
 - Compass Variance

Key Fob Programmable Features

- The following features may also be programmed by using the Key Fob transmitter or the ignition switch and driver's door lock switch.

NOTE:

Pressing the LOCK button while you are inside the vehicle will activate the Vehicle Security Alarm. Opening a door with the Vehicle Security Alarm activated will cause the alarm to sound. Press the UNLOCK button to deactivate the Vehicle Security Alarm.

Unlock On First Press

- To unlock either the driver's side, or all doors, on the first press of the UNLOCK button:
 - Press and hold the LOCK button for at least 4 seconds, but no longer than 10 seconds. Then, press and hold the UNLOCK button while still holding the LOCK button.
 - Release both buttons at the same time.

Auto Unlock Doors On Exit

- To have all of the vehicle doors unlock when any door is opened:
 - Enter your vehicle and close all the doors, and fasten your seat belt.
 - Cycle the ignition switch between the LOCK and ON position four times, ending in the LOCK position (do not start the engine).
 - Press the power door UNLOCK switch to unlock the doors. A single chime will indicate that programming is complete.

ELECTRONICS

Auto Door Lock

- To have the doors lock automatically when the vehicle's speed exceeds 15 mph (24 km/h):
 - Enter your vehicle and close all the doors.
 - Cycle the ignition switch between LOCK and ON and then back to LOCK four times, ending up in the LOCK position (do not start the engine).
 - Press the power door LOCK switch to lock the doors. A single chime will indicate that programming is complete.

Sound Horn With Lock

- To turn the horn chirp on or off when the doors are locked:
 - Press the LOCK button for at least 4 seconds, but no longer than 10 seconds. Then, press the PANIC button while still holding the LOCK button.
 - Release both buttons at the same time.

Flashing Lights With Lock

- The turn signal lights flashing, when the doors are locked or unlocked, feature can be turned on or off. To turn this feature on or off:
 - Press and hold the UNLOCK button for at least 4 seconds, but no longer than 10 seconds. Then, press and hold the LOCK button while still holding the UNLOCK button.
 - Release both buttons at the same time.

UNIVERSAL GARAGE DOOR OPENER (HomeLink®)

- HomeLink® replaces up to three hand-held transmitters that operate devices such as garage door openers, motorized gates, lighting or home security systems. The HomeLink® unit is powered by your vehicles 12 Volt battery.
- The HomeLink® buttons that are located in the overhead console or sunvisor designate the three different HomeLink® channels.
- The HomeLink® indicator is located above the center button.

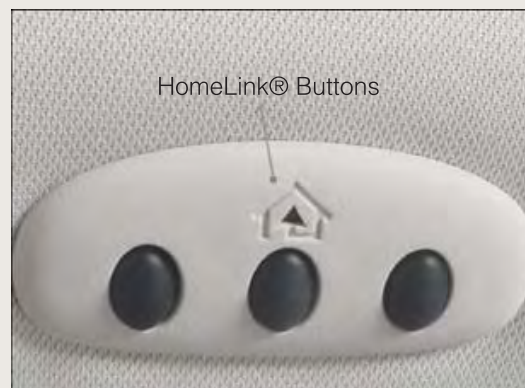

Before You Begin Programming HomeLink®

- Ensure that your vehicle is parked outside of the garage before you begin programming.
- For efficient programming and accurate transmission of the radio-frequency signal, it is recommended that a new battery be placed in the hand-held transmitter of the device that is being programmed to the HomeLink® system.
- Erase all channels before you begin programming. To erase the channels, place the ignition switch into the ON/RUN position, then press and hold the two outside HomeLink® buttons (I and III) for up to 20 seconds or until the red indicator flashes.

NOTE:

Erasing all channels should only be performed when programming HomeLink® for the first time. Do not erase channels when programming additional buttons.

- If you have any problems, or require assistance, please call toll-free 1-800-355-3515 or, on the Internet at www.HomeLink.com for information or assistance.

Programming A Rolling Code

- For programming Garage Door Openers that were manufactured after 1995. These Garage Door Openers can be identified by the “LEARN” or “TRAIN” button located where the hanging antenna is attached to the Garage Door Opener. It is NOT the button that is normally used to open and close the door. The name and color of the button may vary by manufacturer.
- Place the ignition switch into the ON/RUN position.
- Place the hand-held transmitter 1 to 3 in (3 to 8 cm) away from the HomeLink® button you wish to program while keeping the HomeLink® indicator light in view.
- Simultaneously press and hold both the HomeLink® button you want to program and the hand-held transmitter button.
- Continue to hold both buttons and observe the indicator light. The HomeLink® indicator will flash slowly and then rapidly after HomeLink® has received the frequency signal from the hand-held transmitter. Release both buttons after the indicator light changes from slow to rapid.
- At the garage door opener motor (in the garage), locate the “LEARN” or “TRAINING” button. This can usually be found where the hanging antenna wire is attached to the garage door opener motor. Firmly press and release the “LEARN” or “TRAINING” button.

NOTE:

You have 30 seconds in which to initiate the next step after the LEARN button has been pressed.

- Return to the vehicle and press the programmed HomeLink® button twice (holding the button for two seconds each time). If the device is plugged in and activates, programming is complete.

ELECTRONICS

NOTE:

If the device does not activate, press the button a third time (for two seconds) to complete the training.

- To program the remaining two HomeLink® buttons, repeat each step for each remaining button. DO NOT erase the channels.

Programming A Non-Rolling Code

- For programming Garage Door Openers manufactured before 1995.
- Turn the ignition switch to the ON/RUN position.
- Place the hand-held transmitter 1 to 3 in (3 to 8 cm) away from the HomeLink® button you wish to program while keeping the HomeLink® indicator light in view.
- Simultaneously press and hold both the HomeLink® button you want to program and the hand-held transmitter button.
- Continue to hold both buttons and observe the indicator light. The HomeLink® indicator will flash slowly and then rapidly after HomeLink® has received the frequency signal from the hand-held transmitter. Release both buttons after the indicator light changes from slow to rapid.
- Press and hold the programmed HomeLink® button and observe the indicator light.

NOTE:

- If the indicator light stays on constantly, programming is complete and the garage door (or device) should activate when the HomeLink® button is pressed.
- To program the two remaining HomeLink® buttons, repeat each step for each remaining button. DO NOT erase the channels.

Using HomeLink®

- To operate, press and release the programmed HomeLink® button. Activation will now occur for the programmed device (i.e., garage door opener, gate operator, security system, entry door lock, home/office lighting, etc.,). The hand-held transmitter of the device may also be used at any time.

WARNING!

- Your motorized door or gate will open and close while you are programming the universal transceiver. Do not program the transceiver if people or pets are in the path of the door or gate.
- Do not run your vehicle in a closed garage or confined area while programming the transceiver. Exhaust gas from your vehicle contains Carbon Monoxide (CO) which is odorless and colorless. Carbon Monoxide is poisonous when inhaled and can cause you and others to be severely injured or killed.

POWER INVERTER

- A 115 Volt, 150 Watt AC power inverter is located on the front of the center console.
- This outlet can power cellular phones, electronics and other low power devices requiring power up to 150 Watts.

NOTE:

The power inverter is designed with built-in overload protection. If the power rating of 150 Watts is exceeded, the power inverter will automatically shut down.

Once the electrical device has been removed from the outlet, the inverter should automatically reset. If the power rating exceeds approximately 170 Watts, the power inverter may have to be reset manually. To reset the inverter manually, unplug the device and plug it in again. To avoid overloading the circuit, check the power ratings on electrical devices prior to using the inverter.



WARNING!

- To Avoid Serious Injury or Death DO NOT:
 - use a three-prong adaptor
 - insert any objects into the receptacles
 - touch with wet hands
- Close the lid when not in use. If this outlet is mishandled, it may cause an electric shock and failure.

ELECTRONICS

POWER OUTLET

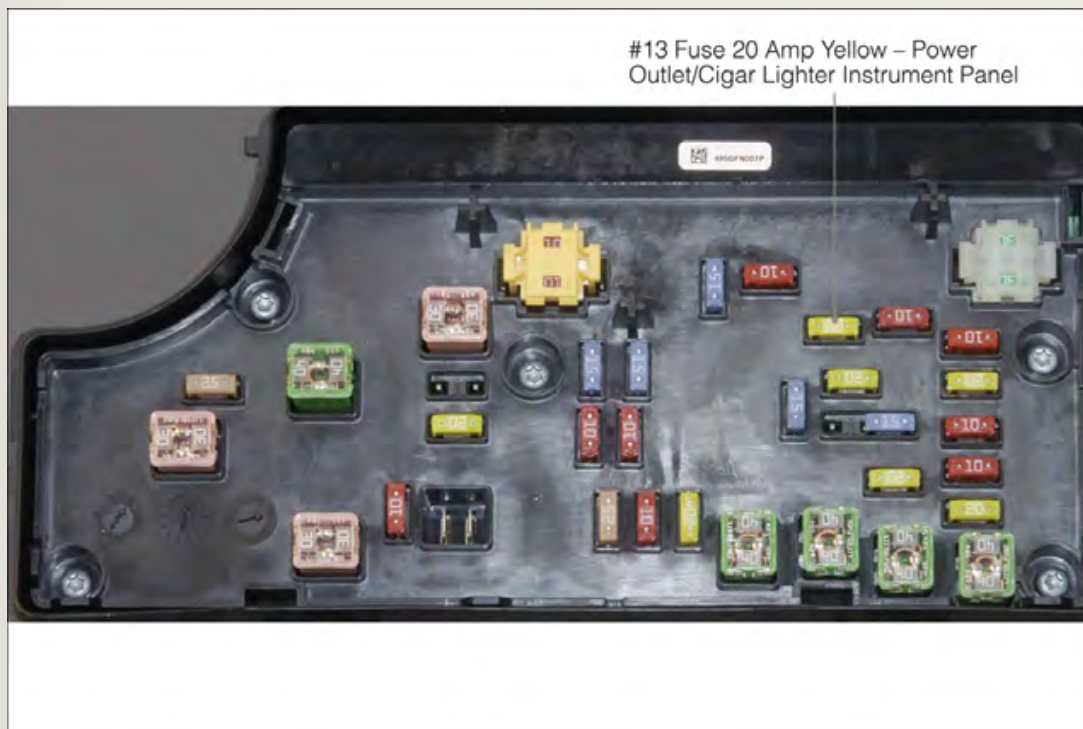

- The power outlet is located on the instrument panel below the climate control and is powered when the ignition switch is in the ON/RUN position.
- The outlet can operate a conventional cigar lighter unit or power accessories designed for use with a standard power outlet adapter.

NOTE:

- Do not exceed the maximum power of 160 Watts (13 Amps) at 12 Volts. If the 160 Watt (13 Amp) power rating is exceeded, the fuse protecting the system will need to be replaced.
- Power outlets are designed for accessory plugs only. Do not insert any other object in the power outlet as this will damage the outlet and blow the fuse. Improper use of the power outlet can cause damage not covered by your new vehicle warranty.

OFF-ROAD CAPABILITIES

FOUR-WHEEL DRIVE OPERATION

- This vehicle has two full time, on-demand, four-wheel-drive (4WD) systems available, Freedom Drive I and Freedom-Drive II. They provide for all-weather, all-terrain capability for added driving security in less-than-ideal road conditions.

Freedom-Drive I™ Four Wheel Drive System

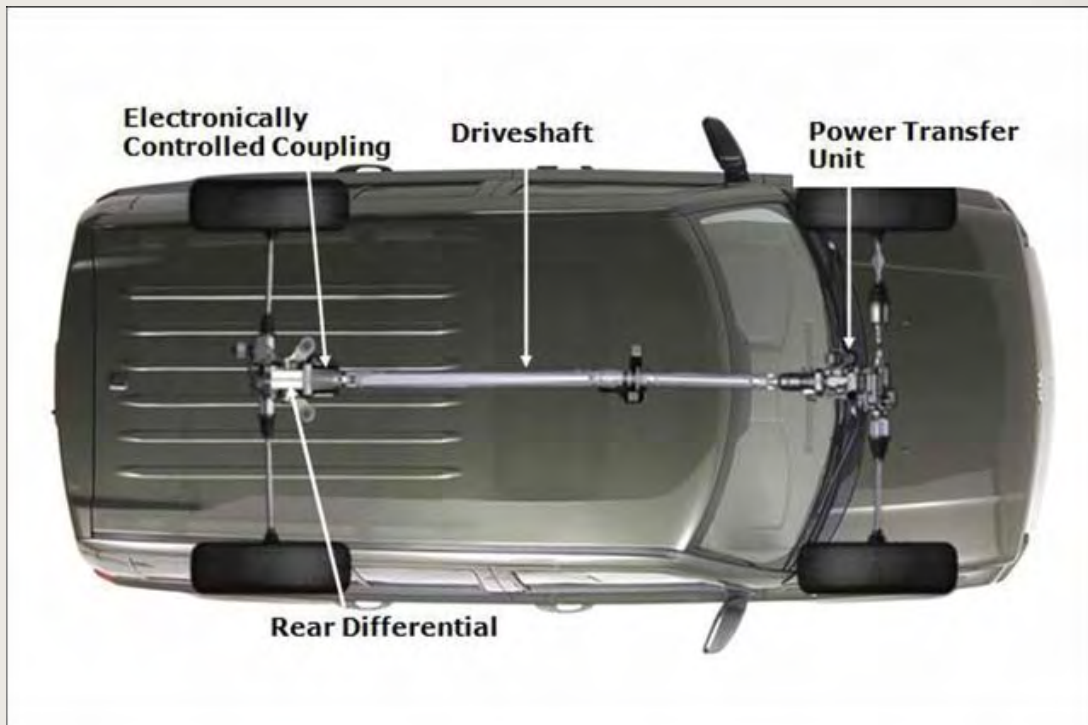

- The vehicle will constantly monitor wheel slippage and transfer power to the axle that can use it the most.
- For additional traction in sand, deep snow or loose traction surfaces, the “4WD Lock” sends equal amounts of the torque to the front and rear axles at low speeds.

OFF-ROAD CAPABILITIES

- To activate, pull the T-handle, located in between the front driver and passenger seats, up once and release. The “4WD Indicator Light” will come on in the cluster.
- This can be done on the fly, at any vehicle speed. To deactivate, simply pull on the T-handle one more time. The “4WD Indicator Light” will then turn off.



Trail Rated® Freedom-Drive II™ Four Wheel Drive System (IF EQUIPPED)



- This system offers all the benefits of Freedom Drive I™ plus the rugged capability of true Trail-Rated off road performance with three additional features:
 - **Off-Road Mode**
 - Pulling up on the T-handle while the gear shift lever is in the Low position activates the Off-Road mode.
- This feature allows power to be sent to all four wheels when additional traction is required while also delivering enhanced off-road capability for water fording, moving on steep grades and rock crawling.
- **Brake Lock Differential**
- This feature helps keep the vehicle moving forward when one wheel loses traction by directing power from the wheel that slips to the wheel with more grip on the same axle providing more traction in off-road situations.
- **Hill Descent Control/Hill Start Assist**
- The Hill Descent Control System maintains vehicle speed while descending hills during off-road driving situations and is available in both low and reverse gears.
- This allows a smooth and controlled hill descent on rough or slippery terrain without the driver needing to touch the brake pedal.
- The Hill Start Assist system assists the driver when starting a vehicle from a stop on a hill.

TRAILER TOWING WEIGHTS (MAXIMUM TRAILER WEIGHT RATINGS)

Engine/ Transmission	Frontal Area	Max. GTW (Gross Trailer Wt.)	Max. Tongue Wt. (See Note)
2.0L Auto/Man	22 sq ft (2.04 sq m)	1,000 lbs (450 kg)	150 lbs (50 kg)
2.4L Auto/Man	22 sq ft (2.04 sq m)	1,000 lbs (450 kg)	150 lbs (50 kg)
2.4L Auto With Freedom Drive II Off Road Package (AWL)	32 sq ft (3.0 sq m)	2,000 lbs (907 kg)	300 lbs (136 kg)
Refer to local laws for maximum trailer towing speeds.			

NOTE:

The trailer tongue weight must be considered as part of the combined weight of occupants and cargo, and should never exceed the weight referenced on the Tire and Loading Information placard.

RECREATIONAL TOWING (BEHIND MOTORHOME, ETC.)

Towing Condition	Wheels OFF the Ground	Manual Transmission	Automatic Transmission
Flat Tow	None	<ul style="list-style-type: none"> Transmission in NEUTRAL Key in ACC Position 	NOT ALLOWED
Dolly Tow	Front	OK (FWD Only)	OK (FWD Only)
	Rear	NOT ALLOWED	NOT ALLOWED
On Trailer	All	OK	OK

NOTE:

Vehicles equipped with **manual transmissions** may be recreationally towed (flat towed) at any legal highway speed, for any distance, if the **manual transmission** is in NEUTRAL and the ignition key is in the ACC position.

CAUTION!

- Do not flat tow any vehicle equipped with a automatic transmission. Damage to the drivetrain will result. If these vehicles require towing, make sure all drive wheels are off the ground.
- Front or rear wheel lifts should not be used. Internal damage to the transmission or transfer case will occur if a front or rear wheel lift is used when recreational towing.

WHAT TO DO IN EMERGENCIES

ROADSIDE ASSISTANCE

- Dial toll-free 1-800-521-2779 for U.S. Residents or 1-800-363-4869 for Canadian Residents.
- Provide your name, vehicle identification number, license plate number, and your location, including the telephone number from which you are calling.
- Briefly describe the nature of the problem and answer a few simple questions.
- You will be given the name of the service provider and an estimated time of arrival. If you feel you are in an “unsafe situation”, please let us know. With your consent, we will contact local police or safety authorities.

INSTRUMENT CLUSTER WARNING LIGHTS



- Electronic Stability Control (ESC) Activation/Malfunction Indicator Light

- If the “ESC Activation/Malfunction Indicator Light” comes on continuously with the engine running, a malfunction has been detected in the ESC system. If this light remains on after several ignition cycles, and the vehicle has been driven several miles (kilometers) at speeds greater than 30 mph (48 km/h), we recommend you do not operate the vehicle. Have the vehicle serviced immediately.
- The “ESC Activation/Malfunction Indicator Light” starts to flash as soon as the tires lose traction and the ESC system becomes active. If the light begins to flash during acceleration, ease up on the accelerator and apply as little throttle as possible. Be sure to adapt your speed and driving to the prevailing road conditions. The light also flashes when TCS is active. To improve the vehicle's traction when starting off in deep snow, sand or gravel, it may be desirable to switch the ESC system to Partial Off mode by momentarily pressing the ESC Off  switch.



- Tire Pressure Monitoring System (TPMS) Light

- Each tire, including the spare (if provided), should be checked monthly, when cold and inflated to the inflation pressure recommended by the vehicle manufacturer on the vehicle placard or tire inflation pressure label. (If your vehicle has tires of a different size than the size indicated on the vehicle placard or tire inflation pressure label, you should determine the proper tire inflation pressure for those tires.)
- As an added safety feature, your vehicle has been equipped with a Tire Pressure Monitoring System (TPMS) that illuminates a low tire pressure telltale when one or more of your tires is significantly under-inflated. Accordingly, when the low tire pressure telltale illuminates, you should stop and check your tires as soon as possible, and inflate them to the proper pressure. Driving on a significantly under-inflated tire causes the tire to overheat and can lead to tire failure. Under-inflation also reduces fuel efficiency and tire tread life, and may affect the vehicle's handling and stopping ability.

WHAT TO DO IN EMERGENCIES

- **IF THE LIGHT STARTS FLASHING INDICATING A LOW TIRE PRESSURE, ADJUST THE AIR PRESSURE IN THE LOW TIRE TO THE AIR PRESSURE SHOWN ON THE VEHICLE PLACARD OR TIRE INFLATION PRESSURE LABEL LOCATED ON THE DRIVER'S DOOR.**

NOTE:

AFTER INFLATION, THE VEHICLE MAY NEED TO BE DRIVEN FOR 20 MINUTES BEFORE THE FLASHING LIGHT WILL TURN OFF.

- Please note that the TPMS is not a substitute for proper tire maintenance, and it is the driver's responsibility to maintain correct tire pressure, even if under-inflation has not reached the level to trigger illumination of the TPMS low tire pressure telltale.
- Your vehicle has also been equipped with a TPMS malfunction indicator to indicate when the system is not operating properly. The TPMS malfunction indicator is combined with the low tire pressure telltale. When the system detects a malfunction, the telltale will flash for approximately one minute and then remain continuously illuminated. This sequence will continue each time the vehicle is restarted as long as the malfunction exists.
- When the malfunction indicator is illuminated, the system may not be able to detect or signal low tire pressure as intended. TPMS malfunctions may occur for a variety of reasons, including the installation of replacement or alternate tires or wheels on the vehicle that prevent the TPMS from functioning properly. Always check the TPMS malfunction telltale after replacing one or more tires or wheels on your vehicle, to ensure that the replacement or alternate tires and wheels allow the TPMS to continue to function properly.

NOTE:

Tire pressures change by approximately 1 psi (7 kPa) per 12° F (7° C) of air temperature change. Keep this in mind when checking tire pressure inside a garage, especially in the Winter. Example: If garage temperature is 68°F (20°C) and the outside temperature is 32°F (0°C), then the cold tire inflation pressure should be increased by 3 psi (21 kPa), which equals 1 psi (7 kPa) for every 12°F (7°C) for this outside temperature condition.

CAUTION!

The TPMS has been optimized for the original equipment tires and wheels. TPMS pressures and warning have been established for the tire size equipped on your vehicle. Undesirable system operation or sensor damage may result when using replacement equipment that is not of the same size, type, and/or style. After-market wheels can cause sensor damage. Do not use tire sealant from a can, or balance beads if your vehicle is equipped with a TPMS, as damage to the sensors may result.

WHAT TO DO IN EMERGENCIES

- Engine Temperature Warning Light

- This light warns of an overheated engine condition.
- If the light turns on and a warning chime sounds while driving, safely pull over and stop the vehicle. If the A/C system is on, turn it off. Also, shift the transmission into NEUTRAL and idle the vehicle. If the temperature reading does not return to normal, turn the engine off immediately.
- We recommend that you do not operate the vehicle or engine damage will occur. Have the vehicle serviced immediately.

WARNING!

A hot engine cooling system is dangerous. You or others could be badly burned by steam or boiling coolant. You may want to call an authorized dealer for service if your vehicle overheats.

BRAKE - Brake Warning Light

- The Brake Warning light illuminates when there is either a system malfunction or the parking brake is applied. If the light is on and the parking brake is not applied, it indicates a possible brake hydraulic malfunction, brake booster problem or an Anti-Lock Brake System problem.
- Please have your vehicle serviced immediately.

WARNING!

Driving a vehicle with the red brake light on is dangerous. Part of the brake system may have failed. It will take longer to stop the vehicle. You could have a collision. Have the vehicle checked immediately.

- Malfunction Indicator Light (MIL)

- Certain conditions, such as a loose or missing gas cap, poor fuel quality, etc., may illuminate the MIL after engine start. The vehicle should be serviced if the light stays on through several typical driving cycles. In most situations, the vehicle will drive normally and not require towing.
- If the MIL flashes when the engine is running, serious conditions may exist that could lead to immediate loss of power or severe catalytic converter damage. We recommend you do not operate the vehicle. Have the vehicle serviced immediately.

- Charging System Light

- This light shows the status of the electrical charging system. If the charging system light remains on, it means that the vehicle is experiencing a problem with the charging system.
- We recommend you do not continue driving if the charging system light is on. Have the vehicle serviced immediately.

WHAT TO DO IN EMERGENCIES



- Oil Pressure Warning Light

- This light indicates low engine oil pressure. If the light turns on while driving, stop the vehicle and shut off the engine as soon as possible. A chime will sound when this light turns on.
- We recommend you do not operate the vehicle or engine damage will occur. Have the vehicle serviced immediately.



- Anti-Lock Brake (ABS) Light

- This light monitors the Anti-Lock Brake System (ABS).
- If the light is not on during starting, stays on, or turns on while driving, we recommend you drive to the nearest service center and have the vehicle serviced immediately.



- Electronic Throttle Control (ETC) Indicator Light

- This light informs you of a problem with the Electronic Throttle Control (ETC) system.
- If a problem is detected, the light will come on while the engine is running. Cycle the ignition when the vehicle has completely stopped and the shift lever is placed in the PARK position; the light should turn off.
- If the light remains lit with the engine running, your vehicle will usually be drivable; however, see an authorized service center immediately. If the light is flashing when the engine is running, immediate service is required and you may experience reduced performance, an elevated/rough idle or engine stall and your vehicle may require towing.



- Air Bag Warning Light

- If the light is not on during starting, stays on, or turns on while driving, have the vehicle serviced by an authorized service center immediately.

4WD! - 4WD System Fault Indicator Light

- When lit solid: There is a 4WD system fault. The 4WD performance will be at a reduced level. We recommend you do not operate the vehicle. Have the vehicle serviced immediately.
- When blinking: The 4WD system is temporarily disabled due to overload condition.



- Transmission Temperature Warning Light

- This light indicates that there is excessive transmission fluid temperature that might occur with severe usage such as trailer towing. If this light turns on, you will experience reduced vehicle performance until the automatic transmission cools down. If the overheating continues, stop the vehicle and run the engine at idle, with the transmission in NEUTRAL, until the light turns off. Once the light turns off, you may continue to drive normally.

WHAT TO DO IN EMERGENCIES

Fuel Cap/Loose Gas Cap Message

- If a “gas cap” message (shown as gASCAP) appears, tighten the gas cap until a “clicking” sound is heard.
- Press the odometer reset button, located below the tachometer, to turn the message off.
- If the message continues to appear for more than three days after tightening the gas cap, see your authorized service center.

Oil Change Indicator

Message

- If an “oil change” message (shown as CHANgE OIL) appears and a single chime sounds, it is time for your next required oil change.

Resetting The Light After Servicing

- Turn the ignition switch to the ON/RUN position (do not start engine).
- Fully depress the accelerator pedal three times within 10 seconds.
- Turn the ignition switch to the OFF/LOCK position.

IF YOUR ENGINE OVERHEATS

- In any of the following situations, you can reduce the potential for overheating by taking the appropriate action.
- On the highways — slow down.
- In city traffic — while stopped, place the transmission in NEUTRAL, but do not increase engine idle speed.

NOTE:

There are steps that you can take to slow down an impending overheat condition:

- If your air conditioner (A/C) is on, turn it off. The A/C system adds heat to the engine cooling system and turning the A/C off can help remove this heat.
- You can also turn the temperature control to maximum heat, the mode control to floor and the blower control to high. This allows the heater core to act as a supplement to the radiator and aids in removing heat from the engine cooling system.

CAUTION!

Driving with a hot cooling system could damage your vehicle. If the temperature gauge reads HOT (H), pull over and stop the vehicle. Idle the vehicle with the air conditioner turned off until the pointer drops back into the normal range. If the pointer remains on HOT (H), and you hear continuous chimes, turn the engine off immediately, and call for service.

WHAT TO DO IN EMERGENCIES

WARNING!

You or others can be badly burned by hot engine coolant (antifreeze) or steam from your radiator. If you see or hear steam coming from under the hood, do not open the hood until the radiator has had time to cool. Never try to open a cooling system pressure cap when the radiator or coolant bottle is hot.

AUTOMATIC TRANSMISSION OVERHEATING

- During sustained high speed driving or trailer towing up long grades on hot days, the automatic transmission oil may become too hot.
- When the transmission overheat warning light  turns on, you will experience reduced performance until the automatic transmission cools down. Once the transmission has cooled down and the light turns off, you may continue to drive normally. If the high speed is maintained, the overheating will continue to occur.
- If the overheating continues, it may become necessary to stop the vehicle and run the engine at idle with the transmission in NEUTRAL until the light turns off.

JACKING AND TIRE CHANGING

Jack Location

- The jack and jack-handle are stowed under the load floor in the cargo area.

Spare Tire Stowage

- The compact spare tire is stowed under the rear load floor in the cargo area.

Spare Tire Removal

- Lift up the load floor cover and remove the hold down.



WHAT TO DO IN EMERGENCIES

Preparations For Jacking

1. Park the vehicle on a firm level surface, avoiding ice or slippery areas.
2. Turn on the Hazard Warning flasher.
3. Set the parking brake.
4. Place the shift lever in PARK (automatic transmission) or REVERSE (manual transmission).
5. Turn OFF the ignition.

Block both the front and rear of the wheel diagonally opposite the jacking position. For example, if changing the right front tire, block the left rear wheel.

NOTE:

Passengers should not remain in the vehicle while the vehicle is being jacked.

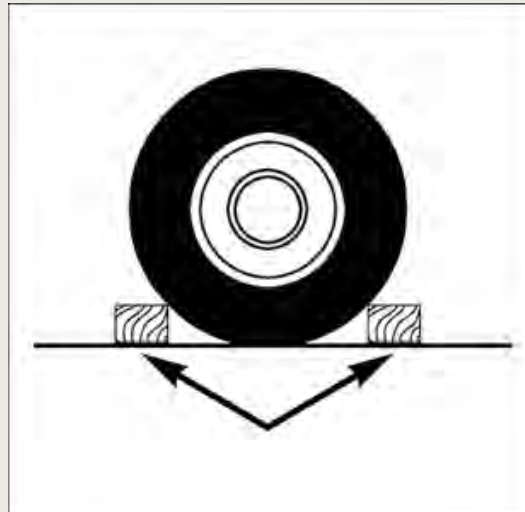

Jacking Instructions

NOTE:

Refer to “Tires — General Information” in “Starting And Operating” in the Owner's Manual on the DVD for further information about the spare tire, it's use, and operation.

1. Remove the scissors jack and lug wrench from the spare wheel as an assembly. Turn the jack screw to the left to loosen the lug wrench and remove the wrench from the jack assembly.
2. Loosen, but do not remove, the wheel nuts by turning them to the left one turn while the wheel is still on the ground.



WHAT TO DO IN EMERGENCIES

NOTE:

- There are front and rear jacking locations on each side of the body. The front locations are outlined by two triangular cutouts, the rear locations by two rectangular cutouts.
 - For vehicles equipped with plastic trim, the plastic has been cut away to expose the jacking locations in the body.
 - Do not raise the vehicle until you are sure the jack is securely engaged.
3. Turn the jack screw to the left until the jack can be placed under the jacking location. Once the jack is positioned, turn the jack screw to the right until the jack head is properly engaged with the lift area closest to the wheel to be changed.
 4. Using the swivel wrench raise the vehicle by turning the jack screw to the right. Raise the vehicle only until the tire just clears the surface and enough clearance is obtained to install the spare tire. Minimum tire lift provides maximum stability.
 5. Remove the wheel nuts and pull the wheel and wheel covers, where applicable, off the hub. Install the spare wheel and wheel nuts with the cone shaped end of the nuts toward the wheel. Lightly tighten the nuts.

NOTE:

The wheel cover is held on the wheel by the wheel nuts. When reinstalling the original wheel, properly align the wheel cover to the valve stem, place the wheel cover onto the wheel, then install the wheel nuts.

6. Lower the vehicle by turning the jack screw to the left.



WHAT TO DO IN EMERGENCIES

7. Finish tightening the nuts. Push down on the wrench while at the end of the handle for increased leverage. Tighten the lug nuts in a star pattern until each nut has been tightened twice. The correct wheel nut torque is 100 ft lbs (135 N·m). If you doubt that you have tightened the nuts correctly, have them checked with a torque wrench by your authorized dealer or service station.
8. Remove the wheel blocks and lower the jack until it is free. Reassemble the lug wrench to the jack assembly and stow it in the spare tire area. Secure the assembly using the means provided.
9. Place the deflated (flat) tire in the cargo area, **have the tire repaired or replaced as soon as possible.**
10. Check the spare tire pressure as soon as possible. Correct the tire pressure as required.

Road Tire Installation

Vehicles Equipped With Wheel Covers

1. Mount the road tire on the axle.
2. To ease the installation process for steel wheels with wheel covers, install two lug nuts on the mounting studs which are on each side of the valve stem. Install the lug nuts with the cone shaped end of the nut toward the wheel. Lightly tighten the lug nuts.
3. Align the valve notch in the wheel cover with the valve stem on the wheel. Install the cover by hand, snapping the cover over the two lug nuts. Do not use a hammer or excessive force to install the cover.
4. Install the remaining lug nuts with the cone shaped end of the nut toward the wheel. Lightly tighten the lug nuts.
5. Lower the vehicle to the ground by turning the jack handle counterclockwise.
6. Finish tightening the lug nuts. Push down on the wrench while at the end of the handle for increased leverage. Tighten the lug nuts in a star pattern until each nut has been tightened twice. The correct tightness of each lug nut is 100 ft/lbs (135 N·m). If in doubt about the correct tightness, have them checked with a torque wrench by your authorized dealer or service station.
7. After 25 miles (40 km) check the lug nut torque with a torque wrench to ensure that all lug nuts are properly seated against the wheel.

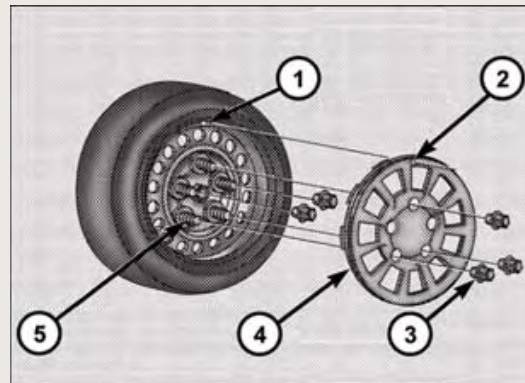

1 — Valve Stem 4 — Wheel Cover
2 — Valve Notch 5 — Mounting Stud
3 — Wheel Lug Nut

WHAT TO DO IN EMERGENCIES

Vehicles Without Wheel Covers

1. Mount the road tire on the axle.
2. Install the remaining lug nuts with the cone shaped end of the nut toward the wheel. Lightly tighten the lug nuts.
3. Lower the vehicle to the ground by turning the jack handle counterclockwise.
4. Finish tightening the lug nuts. Push down on the wrench while at the end of the handle for increased leverage. Tighten the lug nuts in a star pattern until each nut has been tightened twice. The correct tightness of each lug nut is 100 ft/lbs (135 N·m). If in doubt about the correct tightness, have them checked with a torque wrench by your authorized dealer or service station.
5. After 25 miles (40 km) check the lug nut torque with a torque wrench to ensure that all lug nuts are properly seated against the wheel.

CAUTION!

- Do not attempt to raise the vehicle by jacking on locations other than those indicated in the Jacking Instructions for this vehicle.
- Be sure to mount the spare tire with the valve stem facing outward. The vehicle could be damaged if the spare tire is mounted incorrectly.

WHAT TO DO IN EMERGENCIES

WARNING!

- Being under a jacked-up vehicle is dangerous. The vehicle could slip off the jack and fall on you. You could be crushed. Never put any part of your body under a vehicle that is on a jack. If you need to get under a raised vehicle, take it to a service center where it can be raised on a lift.
- Never start or run the engine while the vehicle is on a jack.
- The jack is designed to be used as a tool for changing tires only. The jack should not be used to lift the vehicle for service purposes. The vehicle should be jacked on a firm level surface only. Avoid ice or slippery areas.
- Do not attempt to change a tire on the side of the vehicle close to moving traffic, pull far enough off the road to avoid the danger of being hit when operating the jack or changing the wheel.
- Carefully follow these tire changing warnings to help prevent personal injury or damage to your vehicle:
 - Always park on a firm, level surface as far from the edge of the roadway as possible before raising the vehicle.
 - Turn on the Hazard Warning flasher.
 - Block the wheel diagonally opposite the wheel to be raised.
 - Set the parking brake firmly and set an automatic transmission in PARK; a manual transmission in REVERSE.
- Do not let anyone sit in the vehicle when it is on a jack.
- Do not get under the vehicle when it is on a jack.
- Only use the jack in the positions indicated and for lifting this vehicle during a tire change.
- If working on or near a roadway, be extremely careful of motor traffic.
- To assure that spare tires, flat or inflated, are securely stowed, spares must be stowed with the valve stem facing the ground.
- Raising the vehicle higher than necessary can make the vehicle less stable. It could slip off the jack and hurt someone near it. Raise the vehicle only enough to remove the tire.
- To avoid possible personal injury, handle the wheel covers with care to avoid contact with any sharp edges.
- A loose tire or jack thrown forward in a collision or hard stop could injure the occupants in the vehicle. Have the deflated (flat) tire repaired or replaced immediately.
- To avoid the risk of forcing the vehicle off the jack, do not tighten the lug nuts fully until the vehicle is lowered to the ground. Failure to follow this warning may result in personal injury.

WHAT TO DO IN EMERGENCIES

JUMP-STARTING PROCEDURES

- If your vehicle has a discharged battery it can be jump-started using a set of jumper cables and a battery in another vehicle or by using a portable battery booster pack. Jump-starting can be dangerous if done improperly so please follow the procedures in this section carefully.

NOTE:

When using a portable battery booster pack follow the manufacturer's operating instructions and precautions.

Preparations For Jump-Start

- The battery in your vehicle is located in the front of the engine compartment below the air intake duct. To access the battery remove the air intake duct by turning the two finger screws, located on the radiator support.
1. Set the parking brake, shift the automatic transmission into PARK and turn the ignition to LOCK.
 2. Turn off the heater, radio, and all unnecessary electrical accessories.
 3. If using another vehicle to jump-start the battery, park the vehicle within the jumper cables reach, set the parking brake and make sure the ignition is OFF.

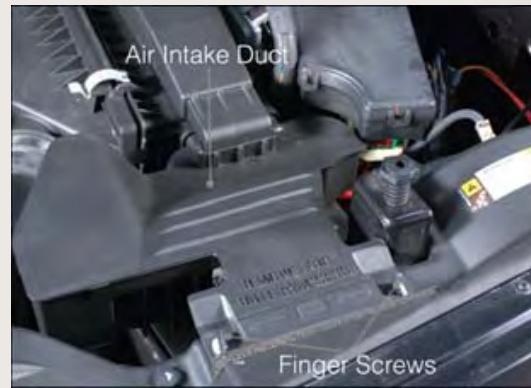

WHAT TO DO IN EMERGENCIES

Jump-Starting Procedure

NOTE:

Remove Air Intake before proceeding with this Jump-Starting procedure.

1. Connect the positive (+) end of the jumper cable to the positive (+) post of the discharged vehicle.
2. Connect the opposite end of the positive (+) jumper cable to the positive (+) post of the booster battery.
3. Connect the negative end (-) of the jumper cable to the negative (-) post of the booster battery.
4. Connect the opposite end of the negative (-) jumper cable to a good engine ground (exposed metal part of the discharged vehicle's engine) away from the battery and the fuel injection system.
5. Start the engine in the vehicle that has the booster battery, let the engine idle a few minutes, and then start the engine in the vehicle with the discharged battery. Once the engine is started, remove the jumper cables in the reverse sequence:
6. Disconnect the negative (-) jumper cable from the engine ground of the vehicle with the discharged battery.
7. Disconnect the negative end (-) of the jumper cable from the negative (-) post of the booster battery.
8. Disconnect the opposite end of the positive (+) jumper cable from the positive (+) post of the booster battery.
9. Disconnect the positive (+) end of the jumper cable from the positive (+) post of the discharged vehicle.
10. Reinstall the air intake duct.

If frequent jump-starting is required to start your vehicle you should have the battery and charging system inspected at your authorized dealer.

CAUTION!

- Accessories that can be plugged into the vehicle power outlets draw power from the vehicle's battery, even when not in use (i.e., cellular phones, etc.). Eventually, if plugged in long enough, the vehicle's battery will discharge sufficiently to degrade battery life and/or prevent the engine from starting.
- Do not use a portable battery booster pack or any other booster source with a system voltage greater than 12 Volts or damage to the battery, starter motor, alternator or electrical system may occur.
- Failure to follow these procedures could result in damage to the charging system of the booster vehicle or the discharged vehicle.

WHAT TO DO IN EMERGENCIES

WARNING!

- Do not attempt jump-starting if the battery is frozen. It could rupture or explode and cause personal injury.
- Take care to avoid the radiator cooling fan whenever the hood is raised. It can start anytime the ignition switch is on. You can be injured by moving fan blades.
- Remove any metal jewelry such as watch bands or bracelets that might make an inadvertent electrical contact. You could be seriously injured.
- Batteries contain sulfuric acid that can burn your skin or eyes and generate hydrogen gas which is flammable and explosive. Keep open flames or sparks away from the battery.
- Do not allow vehicles to touch each other as this could establish a ground connection and personal injury could result.
- Failure to follow this procedure could result in personal injury or property damage due to battery explosion.
- Do not connect the cable to the negative post (-) of the discharged battery. The resulting electrical spark could cause the battery to explode and could result in personal injury.

SHIFT LEVER OVERRIDE

- If a malfunction occurs and the shift lever cannot be moved out of the PARK position, you can use the following procedure to temporarily move the shift lever:
 - To access the shift lever override, locate and remove the removable plug in the right side of the shift lever housing.
 - Firmly set the parking brake.
 - Turn the ignition switch to the ACC or ON position without starting the engine.
 - Press and maintain firm pressure on the brake pedal.
 - Using a screwdriver or similar tool, press and hold the override tab through the access port on the center console.
 - Move the shift lever into the NEUTRAL position.
 - The vehicle may then be started in NEUTRAL.
 - Reinstall the override cover.

WHAT TO DO IN EMERGENCIES

TOWING A DISABLED VEHICLE

Model	Flat Towing (all four wheels on the ground)	Flatbed Towing (all four wheels suspended OFF the ground)	Front Wheels Raised, Rear Wheels on the Ground	Rear Wheels Raised, Front Wheels on the Ground
FWD Without a Key	NOT Permitted	Recommended Method	May Be Used	NOT Permitted
FWD Automatic Transmission With a Key	NOT Permitted	Recommended Method	May Be Used	NOT Permitted
FWD Manual Transmission With a Key	May be Used with the transmission in NEUTRAL	Recommended Method	May Be Used	NOT Permitted
AWD Without a Key	NOT Permitted	Recommended Method	NOT Permitted	NOT Permitted
AWD Automatic Transmission With a Key	NOT Permitted	Recommended Method	NOT Permitted	NOT Permitted
AWD Manual Transmission With a Key	May be Used with the transmission in NEUTRAL	Recommended Method	NOT Permitted	NOT Permitted

WHAT TO DO IN EMERGENCIES

FREEING A STUCK VEHICLE

- If your vehicle becomes stuck in mud, sand or snow, it can often be moved by a rocking motion. Turn your steering wheel right and left to clear the area around the front wheels. Then move the shift lever back and forth between REVERSE and DRIVE. Using minimal accelerator pedal pressure to maintain the rocking motion, without spinning the wheels, is most effective.

NOTE:

To improve the vehicle's traction when starting off in deep snow, sand or gravel, it may be desirable to switch the Electronic Stability Control (ESC) to "Partial Off" mode by momentarily pressing the ESC Off  switch. For further information on ESC, refer to the Owner's Manual on the DVD.

CAUTION!

- When "rocking" a stuck vehicle by moving between REVERSE and DRIVE, do not spin the wheels faster than 15 mph (24 km/h), or drivetrain damage may result.
- Revving the engine or spinning the wheels too fast may lead to transmission overheating and failure. It can also damage the tires. Do not spin the wheels above 30 mph (48 km/h) while in gear (no transmission shifting occurring).

WARNING!

Fast spinning tires can be dangerous. Forces generated by excessive wheel speeds may cause tire damage or failure. A tire could explode and injure someone. Do not spin your vehicle's wheels faster than 30 mph (48 km/h) when you are stuck. Do not let anyone near a spinning wheel, no matter what the speed.

WHAT TO DO IN EMERGENCIES

EVENT DATA RECORDER (EDR)

- This vehicle is equipped with an Event Data Recorder (EDR). The main purpose of an EDR is to record, in certain crash or near crash-like situations, such as an air bag deployment or hitting a road obstacle, data that will assist in understanding how a vehicle's systems performed. The EDR is designed to record data related to vehicle dynamics and safety systems for a short period of time, typically 30 seconds or less. The EDR in this vehicle is designed to record such data as:
 - How various systems in your vehicle were operating.
 - Whether or not the driver and passenger safety belts were buckled/fastened.
 - How far (if at all) the driver was depressing the accelerator and/or brake pedal.
 - How fast the vehicle was traveling.
- These data can help provide a better understanding of the circumstances in which crashes and injuries occur.

NOTE:

EDR data are recorded by your vehicle only if a non-trivial crash situation occurs; no data are recorded by the EDR under normal driving conditions and no personal data (e.g. name, gender, age, and crash location) are recorded. However, other parties, such as law enforcement, could combine the EDR data with the type of personally identifying data routinely acquired during a crash investigation.

- To read data recorded by an EDR, special equipment is required, and access to the vehicle or the EDR is needed. In addition to the vehicle manufacturer, other parties such as law enforcement, that have the special equipment, can read the information if they have access to the vehicle or the EDR.

MAINTAINING YOUR VEHICLE

OPENING THE HOOD

- Pull the release lever located below the instrument panel and in front of the driver's door.
- Raise the hood and locate the safety latch, in the middle of the hood opening.
- Move the safety latch while lifting the hood at the same time.
- Insert the support rod into the slot on the hood.
- To close the hood, remove the support rod and place it in the retaining clip, then lower the hood slowly.



WARNING!

Be sure the hood is fully latched before driving your vehicle. If the hood is not fully latched, it could open when the vehicle is in motion and block your vision. Failure to follow this warning could result in serious injury or death.

MAINTAINING YOUR VEHICLE

ENGINE COMPARTMENT

2.0L Engine

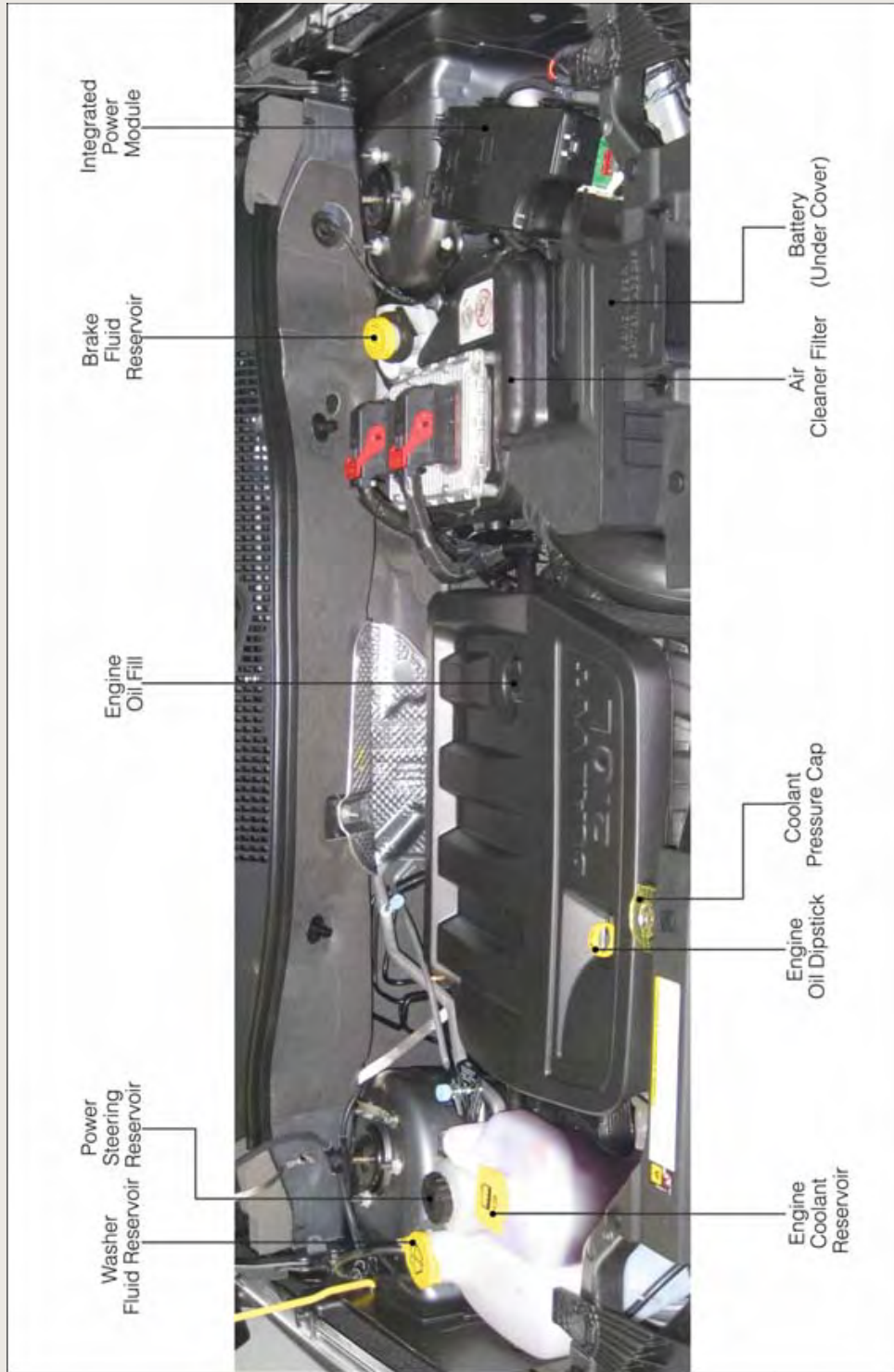

MAINTAINING YOUR VEHICLE

2.4L Engine

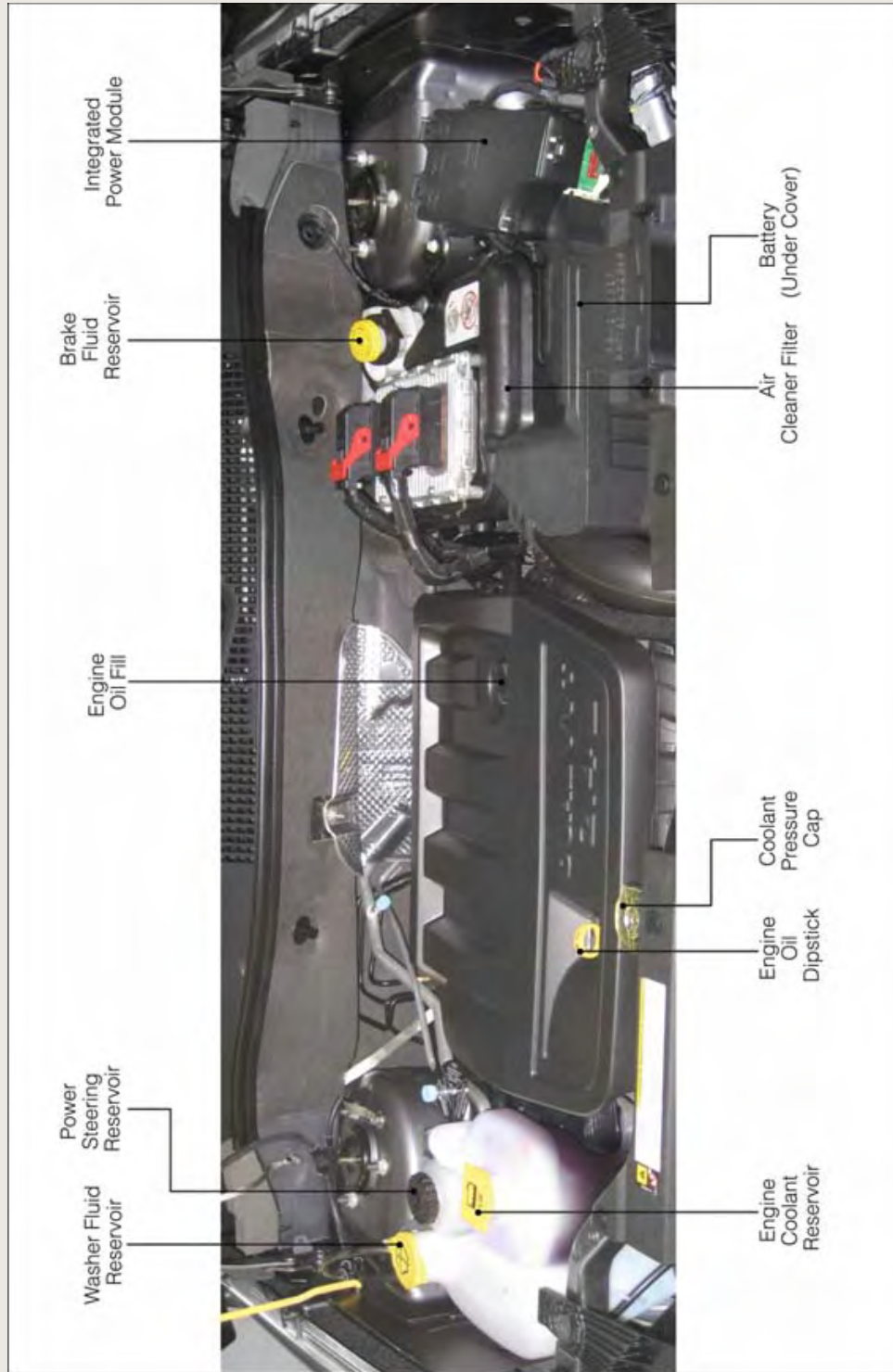

MAINTAINING YOUR VEHICLE

FLUIDS AND CAPACITIES

Component	Fluid, Lubricant, or Genuine Part	Capacities
Engine Coolant– 2.0L, 2.4L Engine	We recommend you use MOPAR® Antifreeze/Coolant Ten Year/ 150,000 Mile Formula OAT (Organic Additive Technology).	7.2 Quarts (6.8 Liters) Includes heater and coolant recovery bottle filled to MAX level.
Engine Oil with Filter– 2.0L, 2.4L Engine	We recommend you use API Certified SAE 5W-20 engine oil, meeting the requirements of Chrysler Material Standard MS-6395. Refer to the engine oil filler cap for correct SAE grade.	4.5 Quarts (4.26 Liters)
Fuel Selection– 2.0L, 2.4L Engine	87 Octane	13.6 Gallons (51.5 Liters) (Approximate)
Engine Oil Filter– 2.0L, 2.4L Engine	We recommend you use MOPAR® Engine Oil Filters.	—
Spark Plugs– 2.0L, 2.4L Engine	We recommend you use MOPAR® Spark Plugs (Gap 0.043 in [1.11 mm])	—
Automatic Transmission (CVT)	We recommend you use MOPAR® CVTF + 4® Automatic Transmission Fluid.	—
Manual Transmission	We recommend you use MOPAR® ATF+4® Automatic Transmission Fluid or equivalent licensed ATF+4® product.	—
Rear Drive Assembly (RDA)	We recommend you use MOPAR® Gear & Axle Lubricant SAE 80W-90 API GL 5.	—
Power Transfer Unit (PTU)	We recommend you use MOPAR® Gear & Axle Lubricant SAE 80W-90 API GL 5.	—
Brake Master Cylinder	We recommend you use MOPAR® DOT 3 and SAE J1703 should be used If DOT 3 is not available, then DOT 4 is acceptable.	—
Power Steering Reservoir	We recommend you use MOPAR® Power Steering Fluid +4 or MOPAR® ATF+4® Automatic Transmission Fluid.	—

MAINTAINING YOUR VEHICLE

CAUTION!

- Mixing of engine coolant (antifreeze) other than specified Organic Additive Technology (OAT) engine coolant (antifreeze), may result in engine damage and may decrease corrosion protection. Organic Additive Technology (OAT) engine coolant is different and should not be mixed with Hybrid Organic Additive Technology (HOAT) engine coolant (antifreeze) or any “globally compatible” coolant (antifreeze). If a non-OAT engine coolant (antifreeze) is introduced into the cooling system in an emergency, it should be flushed with OAT coolant and replaced with the specified OAT engine coolant (antifreeze) as soon as possible.
- Do not use water alone or alcohol-based engine coolant (antifreeze) products. Do not use additional rust inhibitors or antirust products, as they may not be compatible with the radiator engine coolant and may plug the radiator.
- This vehicle has not been designed for use with propylene glycol-based engine coolant (antifreeze). Use of propylene glycol-based engine coolant (antifreeze) is not recommended.

MAINTENANCE SCHEDULE

Your vehicle is equipped with an automatic oil change indicator system. The oil change indicator system will remind you that it is time to take your vehicle in for scheduled maintenance.

Based on engine operation conditions, the oil change indicator message will illuminate. This means that service is required for your vehicle. Operating conditions such as frequent short-trips, trailer tow, extremely hot or cold ambient temperatures will influence when the “Change Oil” or “Oil Change Required” message is displayed. Severe Operating Conditions can cause the change oil message to illuminate as early as 3,500 miles (5,600 km) since last reset. Have your vehicle serviced as soon as possible, within the next 500 miles (805 km).

On Electronic Vehicle Information Center (EVIC) equipped vehicles, “Oil Change Required” will be displayed in the EVIC and a single chime will sound, indicating that an oil change is necessary.

On Non-EVIC equipped vehicles, “Change Oil” will flash in the instrument cluster odometer and a single chime will sound, indicating that an oil change is necessary.

MAINTAINING YOUR VEHICLE

Your authorized dealer will reset the oil change indicator message after completing the scheduled oil change. If a scheduled oil change is performed by someone other than your authorized dealer, the message can be reset by referring to the steps described under “Electronic Vehicle Information Center (EVIC)/Oil Change Required” in “Understanding Your Instrument Panel” or under “Instrument Cluster Description/Odometer/Trip Odometer” in “Understanding Your Instrument Panel” for further information.

NOTE:

Under no circumstances should oil change intervals exceed 10,000 miles (16,000 km) or twelve months, whichever comes first.

Once A Month Or Before A Long Trip:

- Check engine oil level
- Check windshield washer fluid level
- Check the tire inflation pressures and look for unusual wear or damage
- Check the fluid levels of the coolant reservoir, brake master cylinder, power steering and fill as needed
- Check function of all interior and exterior lights

Required Maintenance Intervals.

Refer to the maintenance schedules on the following page for the required maintenance intervals.

At Every Oil Change Interval As Indicated By Oil Change Indicator System:
• Change oil and filter
• Rotate the tires. Rotate at the first sign of irregular wear, even if it occurs before the oil indicator system turns on.
• Inspect battery and clean and tighten terminals as required
• Inspect brake pads, shoes, rotors, drums, hoses and park brake
• Inspect engine cooling system protection and hoses
• Inspect exhaust system
• Inspect engine air cleaner if using in dusty or off-road conditions

MAINTAINING YOUR VEHICLE

Maintenance Chart

Refer to the Maintenance Schedules on the following pages for the required maintenance intervals.

Mileage or time passed (whichever comes first)	20,000	30,000	40,000	50,000	60,000	70,000	80,000	90,000	100,000	110,000	120,000	130,000	140,000	150,000
Or Years:	2	3	4	5	6	7	8	9	10	11	12	13	14	15
Or Kilometers:	32,000	48,000	64,000	80,000	96,000	112,000	128,000	144,000	160,000	176,000	192,000	208,000	224,000	240,000
Additional Inspections														
Inspect the CV joints.	X		X		X		X		X		X		X	
Inspect front suspension, boot seals, tie rod ends, and replace if necessary.	X		X		X		X		X		X		X	
Inspect the brake linings, parking brake function.	X		X		X		X		X		X		X	
Additional Maintenance														
Replace engine air cleaner filter.		X			X			X			X			X
Replace air conditioning/cabin air filter.	X		X		X		X		X		X		X	
Replace spark plugs **		X			X			X			X			X
Flush and replace the engine coolant at 10 years or 150,000 miles (240,000 km) whichever comes first.									X					X
Replace rear drive assembly (RDA) fluid.					X						X			
Replace power transfer unit (PTU) fluid.					X						X			
Change automatic transmission fluid and filter if using your vehicle for any of the following: police, taxi, fleet, or frequent trailer towing.					X									

MAINTAINING YOUR VEHICLE

Mileage or time passed (whichever comes first)	2	3	4	5	6	7	8	9	10	11	12	13	14	15
Or Years:	2	3	4	5	6	7	8	9	10	11	12	13	14	15
Or Kilometers:	32,000	48,000	64,000	80,000	96,000	112,000	128,000	144,000	160,000	176,000	192,000	208,000	224,000	240,000
Change the automatic transmission fluid and filter.											X			
Change the manual transmission fluid if using your vehicle for any of the following: trailer towing, heavy loading, taxi, police, delivery service (commercial service), off-road, desert operation or more than 50% of your driving is at sustained high speeds during hot weather, above 90°F (32°C).				X					X					X
Inspect and replace PCV valve if necessary.									X					

** The spark plug change interval is mileage based only, yearly intervals do not apply.

WARNING!

- You can be badly injured working on or around a motor vehicle. Do only service work for which you have the knowledge and the right equipment. If you have any doubt about your ability to perform a service job, take your vehicle to a competent mechanic.
- Failure to properly inspect and maintain your vehicle could result in a component malfunction and effect vehicle handling and performance. This could cause an accident.

MAINTAINING YOUR VEHICLE

MAINTENANCE RECORD

	Odometer	Date	Signature, Authorized Service Center
20,000 Miles (32,000 km) or 2 Years			
30,000 Miles (48,000 km) or 3 Years			
40,000 Miles (64,000 km) or 4 Years			
50,000 Miles (80,000 km) or 5 Years			
60,000 Miles (96,000 km) or 6 Years			
70,000 Miles (112,000 km) or 7 Years			
80,000 Miles (128,000 km) or 8 Years			

	Odometer	Date	Signature, Authorized Service Center
90,000 Miles (144,000 km) or 9 Years			
100,000 Miles (160,000 km) or 10 Years			
110,000 Miles (176,000 km) or 11 Years			
120,000 Miles (192,000 km) or 12 Years			
130,000 Miles (208,000 km) or 13 Years			
140,000 Miles (224,000 km) or 14 Years			
150,000 Miles (240,000 km) or 15 Years			

MAINTAINING YOUR VEHICLE

FUSES

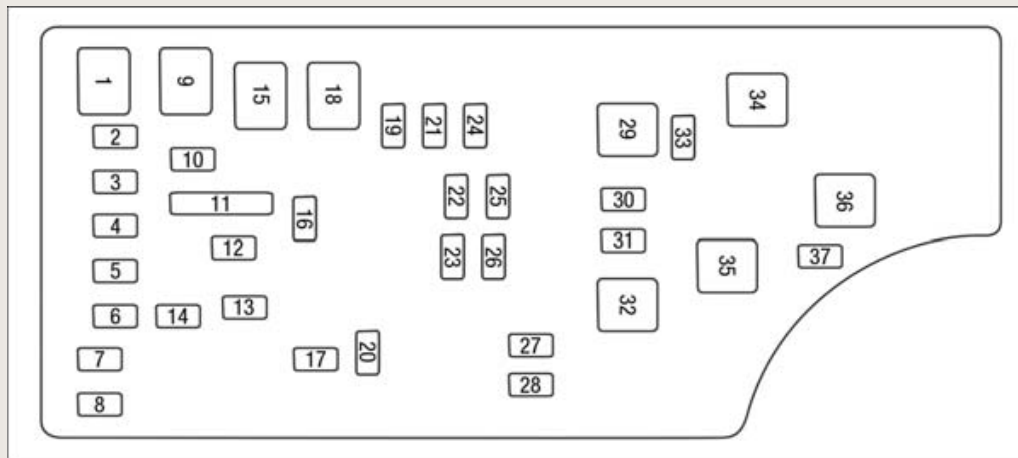

Integrated Power Module (fuses)

- The Integrated Power Module (fuses) is located in the engine compartment near the air cleaner assembly. This center contains cartridge fuses and mini-fuses.

Cavity	Cartridge Fuse	Mini-Fuse	Description
1	Empty		Empty
2		15 Amp Lt Blue	AWD/4WD ECU Feed
3		10 Amp Red	CHMSL Brake Switch Feed
4		10 Amp Red	Ignition Switch Feed/OCM
5		20 Amp Yellow	Trailer Tow
6		10 Amp Red	IOD Sw/Pwr Mir/Steering Cntrl Sdar/Hands-Free Phone
7		30 Amp Green	IOD Sense1
8		30 Amp Green	IOD Sense2
9	40 Amp Green		Power Seats
10		20 Amp Yellow	CCN Power Locks/Interior Lighting
11		15 Amp Lt Blue	Power Outlet
12		20 Amp Yellow	Ign Run/Acc Inverter
13		20 Amp Yellow	Pwr Run/Acc Outlet RR/Dome Lamp/Cigar Lighter
14		10 Amp Red	IOD CCN
15	40 Amp Green		RAD Fan Relay Battery Feed
16		15 Amp Lt Blue	IGN Run/ACC Dome Lamp/Sunroof/ Rear Wiper Motor/ACC Inverter
17		10 Amp Red	IOD Feed Mod-Wcm
18	40 Amp Green		ASD Relay Contact PWR Feed
19		20 Amp Yellow	PWR Amp 1 & Amp 2 Feed
20		15 Amp Lt Blue	IOD Feed Radio

MAINTAINING YOUR VEHICLE

Cavity	Cartridge Fuse	Mini-Fuse	Description
21		10 Amp Red	IOD Feed Intrus Mod/Siren (If Equipped)
22		10 Amp Red	IGN RUN Heat/AC/Compass Sensor
23		15 Amp Lt Blue	ENG ASD Relay Feed 3
24		15 Amp Lt Blue	Power Sunroof Feed
25		10 Amp Red	Heated Mirror (If Equipped)
26		15 Amp Lt Blue	ENG ASD Relay Feed 2
27		10 Amp Red	IGN RUN Only ORC Feed
28		10 Amp Red	IGN RUN ORC/OCM Feed
29			Hot Car (No Fuse Required)
30		20 Amp Yellow	Heated Seat (If Equipped)
31		10 Amp Red	Headlamp Washer Relay Control (If Equipped)
32	30 Amp Pink		ENG ASD Control Feed 1
33		10 Amp Red	ABS MOD/J1962 Conn/PCM
34	30 Amp Pink		ABS Valve Feed
35	40 Amp Green		ABS Pump Feed
36	30 Amp Pink		Headlamp/Washer Control/Smart Glass (If Equipped)
37		25 Amp Natural	Diesel Fuel Heater (If Equipped)

TIRE PRESSURES

- Check the inflation pressure of each tire, including the spare tire, at least monthly and inflate to the recommended pressure for your vehicle.
- The tire pressures recommended for your vehicle are found on the “Tire and Loading Information” label located on the driver’s side door opening.

NOTE:

Refer to the Owner's Manual on the DVD for more information regarding tire warnings and instructions.

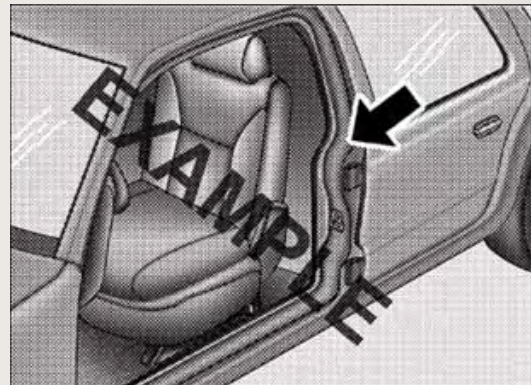

MAINTAINING YOUR VEHICLE

WARNING!

- Overloading of your tires is dangerous. Overloading can cause tire failure, affect vehicle handling, and increase your stopping distance. Use tires of the recommended load capacity for your vehicle. Never overload them.
- Improperly inflated tires are dangerous and can cause collisions. Under-inflation is the leading cause of tire failure and may result in severe cracking, component separation, or “blow out”. Over-inflation reduces a tire’s ability to cushion shock. Objects on the road and chuck holes can cause damage that results in tire failure. Unequal tire pressures can cause steering problems. You could lose control of your vehicle. Over-inflated or under-inflated tires can affect vehicle handling and can fail suddenly, resulting in loss of vehicle control.

WHEEL AND WHEEL TRIM CARE

- All wheels and wheel trim, especially aluminum and chrome plated wheels, should be cleaned regularly with a mild soap and water to prevent corrosion.
- To remove heavy soil and/or excessive brake dust, use MOPAR® Wheel Cleaner or equivalent or select a non-abrasive, non-acidic cleaner.

CAUTION!

Do not use scouring pads, steel wool, a bristle brush, or metal polishes. Do not use oven cleaner. These products may damage the wheel's protective finish. Avoid automatic car washes that use acidic solutions or harsh brushes that may damage the wheel's protective finish. Only MOPAR® Wheel Cleaner or equivalent is recommended.

EXTERIOR BULBS

LIGHT BULBS – Exterior	Bulb Number
Low Beam Headlamp	H11
High Beam Headlamp	9005
Front Park/Turn Signal	7444NA
Front Side Marker Lamp	194
Front Fog Lamp	H11
Center High Mounted Stop Lamp (CHMSL)	LED Assembly (Serviced at Authorized Dealer)
Rear Tail/Stop Lamp	LED Assembly (Serviced at Authorized Dealer)
Rear Turn Lamp	7440NA (WY21W) Amber
Backup Lamp	7440 (W21W) Crystal
License Lamp	W5W

CONSUMER ASSISTANCE

CHRYSLER GROUP LLC CUSTOMER CENTER

P.O. Box 21-8004 Auburn Hills, MI 48321-8004 Phone: 1-877-426-5337

CHRYSLER CANADA INC. CUSTOMER CENTER

P.O. Box 1621 Windsor, Ontario N9A 4H6 Phone: 1-800-465-2001 (English)
Phone: 1-800-387-9983 (French)

ASSISTANCE FOR THE HEARING IMPAIRED

- To assist customers who have hearing difficulties, the manufacturer has installed special TDD (Telecommunication Devices for the Deaf) equipment at its customer center. Any hearing or speech impaired customer, who has access to a TDD or a conventional teletypewriter (TTY) in the United States, can communicate with the manufacturer by dialing 1-800-380-CHRY. Canadian residents with hearing difficulties that require assistance can use the special needs relay service offered by Bell Canada. For TTY teletypewriter users, dial 711 and for Voice callers, dial 1-800-855-0511 to connect with a Bell Relay Service operator.

WARNING!

Engine exhaust, some of its constituents, and certain vehicle components contain, or emit, chemicals known to the State of California to cause cancer and birth defects, or other reproductive harm. In addition, certain fluids contained in vehicles and certain products of component wear contain, or emit, chemicals known to the State of California to cause cancer and birth defects, or other reproductive harm.

PUBLICATIONS ORDERING

- **If you are the first registered retail owner of your vehicle**, you may obtain one free printed copy of the Owner's Manual, Warranty Booklet or Radio Manuals on your DVD by calling 1-877-426-5337 (U.S.) or 1-800-387-1143 (Canada) or by contacting your dealer.
- Replacement User Guide kits or DVDs or, if you prefer, additional printed copies of the Owner's Manual, Warranty Booklet or Radio Manuals may be purchased by visiting www.techauthority.com or by calling 1-877-890-4038 (U.S.) or 1-800-387-1143 (Canada). Visa, Master Card, American Express and Discover orders are accepted. If you prefer mailing your order, please call the above numbers for an order form.

NOTE:

- A street address is required when ordering manuals (no P.O. Boxes).
- The Owner's Manual and User Guide electronic files are also available on the Chrysler, Jeep, Ram Truck and Dodge websites.
- Click on the "For Owners" tab, select "Owner/Service Manuals", then select your desired model year and vehicle from the drop down lists.

CONSUMER ASSISTANCE

REPORTING SAFETY DEFECTS IN THE 50 UNITED STATES AND WASHINGTON, D.C.

- If you believe that your vehicle has a defect that could cause a collision or cause injury or death, you should immediately inform the National Highway Traffic Safety Administration (NHTSA) in addition to notifying the manufacturer.
- If NHTSA receives similar complaints, it may open an investigation, and if it finds that a safety defect exists in a group of vehicles, it may order a recall and remedy campaign. However, NHTSA cannot become involved in individual problems between you, your authorized dealer and the manufacturer.
- To contact NHTSA, you may either call the Auto Safety Hotline toll free at 1-888-327-4236 (TTY: 1-800-424-9153), or go to <http://www.safercar.gov>; or write to: Administrator, NHTSA, 1200 New Jersey Avenue, SE., West Building, Washington, D.C. 20590. You can also obtain other information about motor vehicle safety from <http://www.safercar.gov>.

In Canada

- If you believe that your vehicle has a safety defect, you should contact the Customer Service Department immediately. Canadian customers who wish to report a safety defect to the Canadian government should contact Transport Canada, Motor Vehicle Defect Investigations and Recalls at 1-800-333-0510 or go to <http://www.tc.gc.ca/eng/roadsafety/safedrivers-childsafety-index-53.htm>
- French Canadian customers who wish to report a safety defect to the Canadian government should contact Transport Canada, Motor Vehicle Defect Investigations and Recalls at 1-800-333-0510 or go to <http://www.tc.gc.ca/securiteroutiere/>

MOPAR ACCESSORIES

AUTHENTIC ACCESSORIES BY MOPAR®

- The following highlights just some of the many Authentic Jeep Accessories by Mopar featuring a fit, finish, and functionality specifically for your Jeep Compass.
- In choosing Authentic Accessories you gain far more than expressive style, premium protection, or extreme entertainment, you also benefit from enhancing your vehicle with accessories that have been thoroughly tested and factory-approved.
- For the full line of Authentic Jeep Accessories by Mopar, visit your local Jeep dealership or online at mopar.com.

CHROME:

- Mirror Covers
- Fuel Filler Door
- Door Handles

EXTERIOR:

- Sunroof Air Deflector
- Hitch Receiver
- Roadside Safety Kit
- 18" Black Painted Cast Aluminum Wheels
- Front Air Deflector
- Vehicle Cover
- Tent Kit
- Winter Wheel
- Molded Splash Guards
- Front Air Deflector
- 18" Chrome-Clad Aluminum Wheels

INTERIOR:

- Premium Carpet Floor Mats
- Slush Mats
- Cargo Tray
- Cargo Tote
- Door Sill Guards
- Ambient Light Kit
- Shift Knob
- Bright Pedal Kit
- Heated Seats
- Katzkin Leather Interiors

ELECTRONICS:

- Portable Navigation Systems
- iPod® Adapter
- Remote Start
- Uconnect® Web (WiFi)
- Media Center upgrades
- Electronic Vehicle Tracking System (EVTS)
- Uconnect® Phone
- DVD Rear Seat Video

CARRIERS:

- Hitch-mount Bike Carrier
- Roof Mount Bike Carrier
- Roof Mount Ski and Snowboard Carrier
- Roof Mount Water Sports Carrier
- Roof Top Cargo Carrier
- Sport Utility Bars
- Roof Box Cargo Carrier
- Roof Mount Canoe Carrier

- iPod® is a registered trademark of Apple, Inc.
- Kicker® is a registered trademark of Stillwater Designs and Audio, Inc.

INDEX

Airbag13	Engine	
Air Conditioning25	Break-In Recommendations20
Alarm, Panic10	Compartment88
Arming Theft System		Jump Starting81
(Security Alarm).11	Oil Selection90
Automatic Temperature		Overheating74
Control (ATC)25	Event Data Recorder86
Automatic Transmission		Exterior Lights98
Fluid Type90		
Overheating75	Flash-To-Pass21
Axle Fluid90	Fluid Capacities90
		Fluids90
Belts, Seat12	Fog Lights21
Brake Fluid90	Folding Front Passenger Seat17
Break-In Recommendations,		Folding Rear Seat18
New Vehicle20	Four Wheel Drive Operation67
Bulb Replacement98	Freeing A Stuck Vehicle85
		Front Heated Seats19
Calibration, Compass60	Fuel	
Change Oil Indicator74	Filler Cap (Gas Cap)74
Changing A Flat Tire75	Specifications90
Child Restraint14		
Child Restraint Tether Anchors14	Garage Door Opener (HomeLink®)62
Compass Calibration60	Gas Cap (Fuel Filler Cap)74
Cooling System			
Coolant Capacity90	Headlights21
Cruise Control (Speed Control)23	Dimmer Switch21
Cruise Light23	High Beam21
Customer Assistance99	Heated Seats19
		High Beam/Low Beam Select	
Defects, Reporting100	(Dimmer) Switch21
Dimmer Control21	HomeLink® (Garage Door Opener)62
Dimmer Switch, Headlight21	Hood Release87
Disarming, Theft System11		
		Instrument Cluster	
Electronics		Indicators9
Your Vehicle's Sound System28	Instrument Cluster Warning Lights8
Electronic Speed Control		Intermittent Wipers (Delay Wipers)22
(Cruise Control)23	Introduction2
Electronic Stability Control (ESC)70	Inverter Outlet (115V)65
Electronic Vehicle Information		Inverter, Power65
Center (EVIC)60, 61	iPod®/USB/MP3 Control52
Emergency, In Case of		Bluetooth Streaming Audio59
Brake Warning Light72		
Jacking75		
Jump Starting81		
Overheating74		

INDEX

Jacking Instructions76	Seats16
Jack Location75	Steering90
Jack Operation75, 76	Preparation for Jacking76
Jump Starting.81	Programmable Electronic Features . .	.61
Key Fob10	Rain Sensitive Wiper System22
Key Fob Programmable Features . .	.61	Rear Seat, Folding18
Lane Change and Turn Signals21	Recreational Towing69
Lane Change Assist21	Remote Starting System11
LATCH (Lower Anchors and Tether for CHildren).14	Replacement Bulbs98
Lights		Reporting Safety Defects.100
Engine Temperature Warning . .	.72	Roll Over Warning4
Headlights21	Schedule, Maintenance91
Park21	Seat Belts12
Tire Pressure Monitoring (TPMS)70	Seats.16
Transmission Warning73	Adjustment16
Turn Signal21	Folding Front Passenger17
Warning (Instrument Cluster Description)8	Heated19
Locks		Power16
Liftgate, Tailgate10	Rear Folding18
Maintenance Record95	Shift Lever Override83
Maintenance Schedule91	Signals, Turn21
Malfunction Indicator Light (Check Engine)72	Spare Tire75
MOPAR® Accessories.101	Spark Plugs90
Navigation Voice Prompt Volume . .	.45	Speed Control	
New Vehicle Break-In Period20	Accel/Decel23
Oil Change Indicator74	Cancel23
Oil, Engine		Distance Setting (ACC Only)23
Capacity90	Starting	
Outlet		Remote11
Power66	Steering	
Overheating, Engine74	Tilt Column18
Panic Alarm10	Steering Wheel Audio Controls52
Placard, Tire and Loading Information97	Supplemental Restraint System - Airbag13
Power		Theft System Arming.11
Inverter65	Theft System Disarming11
Outlet (Auxiliary Electrical Outlet)66	Tilt Steering Column18
		Tires	
		Air Pressure97
		Changing75
		Jacking75
		Spare Tire75
		Towing69
		Disabled Vehicle84
		Recreational69

INDEX

Trailer Towing		
Trailer and Tongue Weight69	
Trailer Weight69	
Transmission		
Fluid90	
Turn Signals.21	
Uconnect® Voice Command57	
Voice Command57	
Voice Prompt Volume		
Navigation45	
Volume		
Navigation Voice Prompt45	
Warning, Roll Over4	
Washer		
Rear22	
Washers, Windshield22	
Wheel and Wheel Trim Care98	
Wind Buffeting27	
Windshield Washers22	
Windshield Wipers22	
Wiper, Rear22	

FREQUENTLY ASKED QUESTIONS

GETTING STARTED

- How do I install my LATCH Equipped Child Seat? pg. 14
- How do my heated seats operate? pg. 19

ELECTRONICS

Which radio is in my vehicle?

- Uconnect® 130 pg. 30
- Uconnect® 130 with Satellite Radio pg. 32
- Uconnect® 230 pg. 35
- Uconnect® 430/430N pg. 38

How do I activate the Audio Jack?

- Uconnect® 130 pg. 37
- Uconnect® 130 with Satellite Radio pg. 37
- Uconnect® 230 pg. 37
- Uconnect® 430/430N pg. 42

How do I set the clock on my radio?

- Uconnect® 130 pg. 35
- Uconnect® 130 with Satellite Radio pg. 35
- Uconnect® 230 pg. 35
- Uconnect® 430/430N pg. 38
- How do I use the Navigation feature? pg. 45
- How do I pair my cell phone via Bluetooth® with the Uconnect® Hands-Free Voice Activation System? pg. 54
- How do I configure my Universal Garage Door Opener (HomeLink)? pg. 62

UTILITY

- How do I know how much I can tow with my Jeep Compass? pg. 69

WHAT TO DO IN EMERGENCIES

- What do I do if my TPMS warning light is blinking? pg. 70
- How do I change a flat tire? pg. 75
- How do I Jump-Start my vehicle? pg. 81

MAINTAINING YOUR VEHICLE

- Where is my Fuse Block located? pg. 96
- What type of oil do I use? pg. 90
- How often should I change my engine's oil? pg. 91
- What should my tire pressure be set at? pg. 97

This guide has been prepared to help you get quickly acquainted with your new Jeep and to provide a convenient reference source for common questions. However, it is not a substitute for your Owner's Manual.

For complete operational instructions, maintenance procedures and important safety messages, please consult your Owner's Manual, Navigation/Uconnect® Manuals and other Warning Labels in your vehicle.

Not all features shown in this guide may apply to your vehicle. For additional information on accessories to help personalize your vehicle, visit www.mopar.com or your local Jeep dealer.



Driving and Alcohol:

Drunken driving is one of the most frequent causes of collisions. Your driving ability can be seriously impaired with blood alcohol levels far below the legal minimum. If you are drinking, don't drive. Ride with a designated non-drinking driver, call a cab, a friend, or use public transportation.

WARNING!

Driving after drinking can lead to a collision. Your perceptions are less sharp, your reflexes are slower, and your judgment is impaired when you have been drinking. Never drink and then drive.

Jeep.com



Download a free Vehicle Information App by visiting your application store, Keyword (Jeep Vehicle Info), or scanning the Microsoft Tag. To put Microsoft Tags to work for you, use your mobile phone's browser or App store to download a Microsoft Tag reader, like the free one at www.gettag.mobi. Then follow the directions to scan the code.

Download a FREE electronic copy of the Owner's Manual or Warranty Booklet by visiting the Owners tab at:
www.Jeep.com (U.S.) or
www.Jeep.ca (Canada).

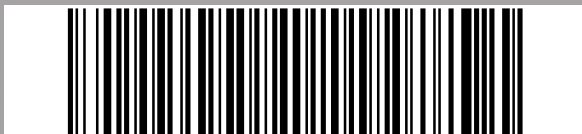

13MK49-926-AA
Compass
Third Edition
User Guide

